



Chirurgisches Nahtmaterial

Surgical suture material

Chirurgisches Nahtmaterial

Surgical Suture Material



- für Praxis und OP
- gezielter Einsatz bei jeder Art von Wundversorgung
- resorbierbares Nahtmaterial unterstützt die natürlichen Reparaturvorgänge
- nicht-resorbierbare Fadenmaterialien garantieren dauerhafte Unterstützung und beste Bioverträglichkeit

- *for practice and surgery*
- *employed specifically in any form of wound care*
- *absorbable suture materials underpin the natural processes of repair*
- *non-absorbable suture materials guarantee lasting support and optimal biocompatibility*



In der Natur müssen verletzte oder zerstörte Gewebeschichten rasch geschlossen werden, um die Integrität und Funktion des Organismus aufrecht zu erhalten. Diese Vorgehensweise hat der Mensch von der Natur übernommen.

Ein Ziel der modernen Wundversorgung ist dabei in erster Linie der Erhalt noch intakter Gewebe und die Unterstützung der geschädigten Bereiche. Unsere Nahtmaterialien auf der Basis bioverträglicher Rohstoffe ermöglichen den gezielten Einsatz bei jeder Art der Wundversorgung und garantieren bestmögliche Gewebeverträglichkeit.

Chirurgisches Nahtmaterial dient als typisches Medizinprodukt zur Reparatur von Geweben. Noch immer werden die meisten Wundverschlüsse mit Nähten ausgeführt. Dabei ist die mechanische Eigenschaft der eingesetzten Materialien von größter Bedeutung, um die verlorene Festigkeit zeitweilig zu ersetzen.

Resorbierbares Nahtmaterial, wie z.B. PGA RESORBA®, unterstützen dabei die natürlichen Reparaturvorgänge, bis Form und Funktion wieder hergestellt sind. Anschließend werden diese im Organismus abgebaut.

Nicht-resorbierbare Fadenmaterialien (z.B. MOPYLEN®) garantieren dauerhafte Unterstützung und beste Bioverträglichkeit, wie sie insbesondere bei Langzeitimplantaten gefordert wird.

In nature, tissue layers that have been damaged or destroyed must be closed promptly to maintain the integrity and normal functioning of the body. Man has adopted this process from nature.

One primary aim of modern wound care is to preserve tissues that are still intact, and to support areas that have been damaged. Our suture products, created from biocompatible starting materials, can be employed specifically in any form of wound care and guarantee the best possible tissue tolerance.

Surgical suture materials are a typical medical product used for repairing tissues. Sutures are still employed for the closure of most wounds. The mechanical properties of suture materials are therefore of great importance if they are to make good the temporary loss of tissue integrity and strength.

Absorbable suture materials such as PGA RESORBA® underpin the natural processes of repair until form and function have been restored. They are then broken down within the body.

Non-absorbable suture materials such as MOPYLEN® guarantee lasting support and optimal biocompatibility, essential requirements for long-term implants.

RESORBA Medical GmbH · Am Flachmoor 16 · 90475 Nürnberg · Germany
Tel. +49 9128 / 91 15 0 · Fax +49 9128 / 91 15 91 · infomail@resorba.com · www.resorba.com

Inhaltsübersicht

Allgemeine Übersicht	Seite
PEEL-eco-Pack	3
Micro-Pack	4
Verpackungen	5
Organisationshilfen	6
Fadentabelle	7
Symbole	8-9
Tipps / Die Nadel	10
Nadel-Daten	11-13
Nadel-Programm	14-18
Materialtabelle	19
Resorption	20

Produktübersicht

- PGA *resoquick*TM
- GLYCOLON®
- PGA RESORBA®
- PDO RESORBATM
- MOPYLEN®
- RESOPREN®
- POLYESTER
- SUPOLENE
- NYLON
- RESOLON®
- SUPRAMID
- SEIDE
- STAHLDRAHT
- DENTAL KOMBINATIONEN
- SPEZIALKOMBINATIONEN
- FEDERÖHRNADELN – UNSTERIL / STERIL

Index

General Information	Page
<i>PEEL-eco-Pack</i>	3
<i>Micro-Pack</i>	4
<i>Types of packaging</i>	5
<i>Organizational support</i>	6
<i>Suture Table</i>	7
<i>Symbols</i>	8-9
<i>Tips / The needle</i>	10
<i>Needle data</i>	11-13
<i>Needle range</i>	14-18
<i>Table of materials</i>	19
<i>Absorption</i>	20

Product Range

- PGA *resoquick*TM
- GLYCOLON®
- PGA RESORBA®
- PDO RESORBATM
- MOPYLEN®
- RESOPREN®
- POLYESTER
- SUPOLENE
- NYLON
- RESOLON®
- SUPRAMID
- SILK
- STAINLESS STEEL
- DENTAL COMBINATIONS
- SPECIALIST PRODUCTS
- SPRING-EYE-NEEDLES – NON STERILE / STERILE

Peel-eco-Pack

**Eine Kombination aus peel-fähiger Umverpackung und multifunktionaler Innenverpackung.
A combination of peelable outer sachet and multifunctional inner sachet.**

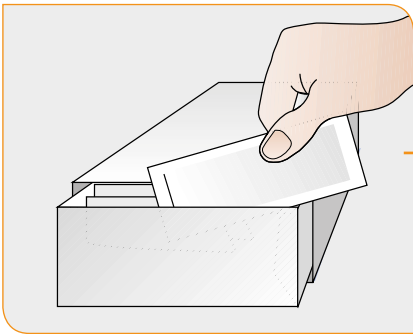

1. Entnahme der Peel-Packung aus dem Vorratskarton.

Remove the peel pack from the storage box.

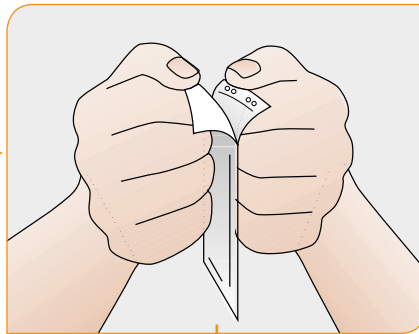

2. Der Springer greift die beiden Aufziehlaschen am oberen Ende der Packung und öffnet diese durch gleichmäßiges Peelen.

The circulating nurse grasps the two tabs at the upper end of the pack and opens them by peeling them apart evenly.



3. Steriler Inhalt wird kontaminationsfrei angereicht.

The sterile contents are passed to the surgeon without contaminating them.

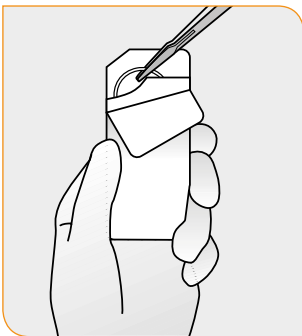

Einzelpack / Nadel-Faden-Kombination

Beim Umklappen der perforierten Lasche wird die Nadel freigelegt. Diese wird anschließend mit dem Nadelhalter entnommen.

Individual pack / needle-thread combination

The needle is exposed by folding back the perforated tab and then withdrawn with the needle holder.

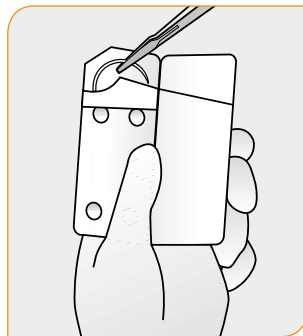

Einzelpack / Nadel-Faden-Kombination

Durch Aufklappen des Fadenträgers wird die Nadel freigelegt. Diese wird anschließend mit dem Nadelhalter entnommen.

Individual pack / needle-thread combination

The needle is exposed by folding out the suture carrier and then withdrawn with the needle holder.

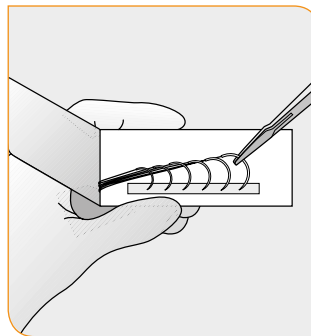

Multipack

Durch seitliches Aufklappen der Papierabdeckung werden die Nadeln freigelegt und anschließend einzeln (nacheinander) mittels Nadelhalter entnommen.

Multi pack

The needles are exposed by folding the paper cover to the side. They are then withdrawn individually (one after another) with the needle holder.

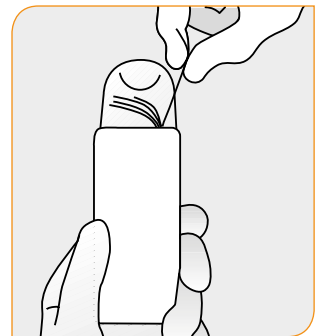

Einzelfadenpackung

Nach Aufklappen der oberen Lasche können die Einzelfäden in beliebiger Reihenfolge entnommen werden.

Pre-cut sutures

After the upper tab has been folded back the individual threads can be withdrawn in any order.

Micro-Pack

Packungen mit Schaumstoff-Trägern für die Mikro- und Augenchirurgie.
Packs with foam carriers for microsurgery and ophthalmic surgery.

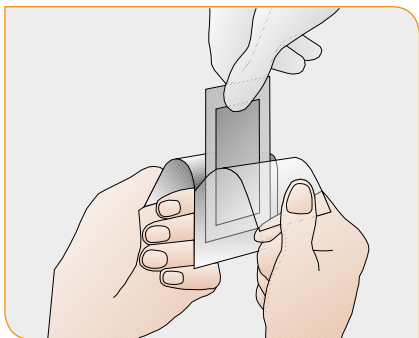

1. Aufpeelen des unsterilen Außenbeutels und kontaminationsfreies Anreichen des sterilen Innenbeutels.

Peel open the unsterile outer sachet and grasp the sterile inner sachet without contaminating it.

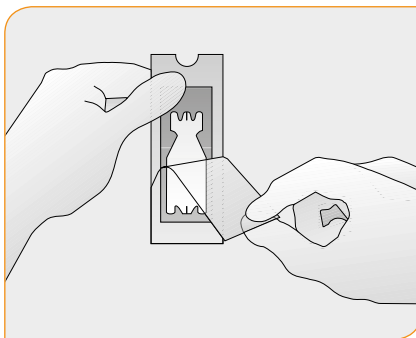

2. Aufpeelen des sterilen Innenbeutels.

Peel open the sterile inner sachet.

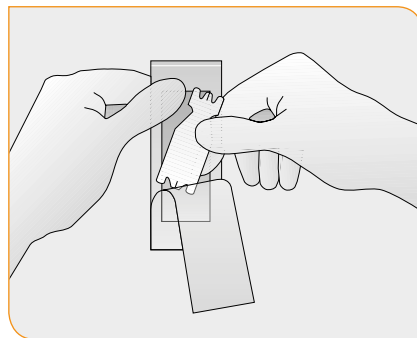

3. Vorsichtige Entnahme des sterilen Fadenträgers aus dem Blisterbeutel.

Carefully remove the sterile suture carrier from the blister.

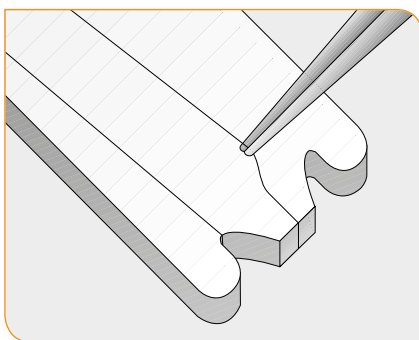

4. Vor Nadelentnahme fixierten Faden mit Pinzette vom Träger lösen.

Before removing the needle, separate the thread from the carrier with forceps.

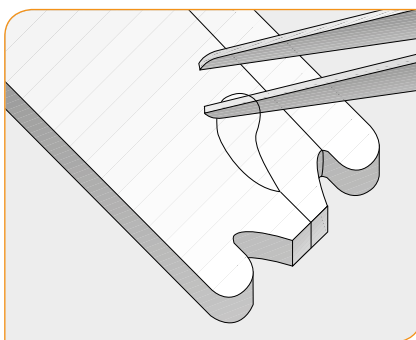

5. Bei doppelt armiertem Faden, erst Fadenschleife lösen bzw. durchtrennen, dann Faden mit Pinzette vom Träger lösen.

In the case of double-armed threads, firstly separate/cut the needle loop and then separate the thread from the carrier with forceps.

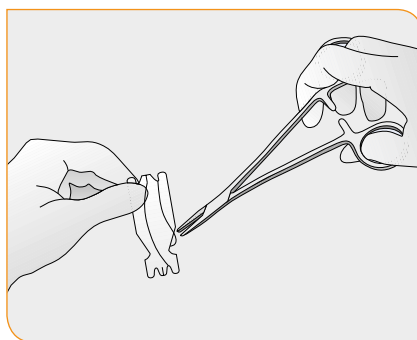

6. Nadel mit Nadelhalter fassen und durch leichtes Drehen vom Träger nehmen.

Grasp the needle with the needle holder and remove it from the carrier by gently rotating it.

7. Während der Operation kann die Nadel im sterilen Träger „geparkt“ werden. Nach der Operation dient der Träger zur Aufnahme und Kontrolle der eingesetzten Nadeln.

During the operation the needle can be „parked“ in the sterile carrier. After the operation the carrier serves as a recipient for checking the number of needles used.

Verpackungen / Types of packaging

Multi-L-Pack Multi-L-Pack

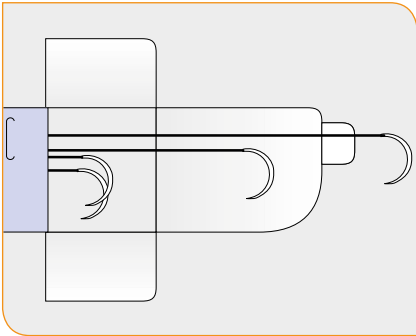

Spezielle Kombinationen werden zur Vermeidung des Memory-Effekts im Multi-L-Pack angeboten. Dieser ermöglicht die problemlose und schnelle Entnahme.

Special combinations are available for preventing the memory effect in the Multi-L-Pack. This ensures rapid, problem-free removal.

Flachspule Dispenser packaging

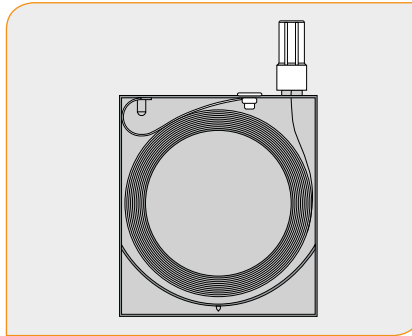

Das Nahtmaterial kann aseptisch aus der Flachspule entnommen werden. Chirurgische Nahtmaterialien in Flachspulen kommen überwiegend in der Veterinärmedizin zum Einsatz. Diese Verpackungsart ist zweckbestimmt sicher und ökonomisch.

Suture material can be removed aseptically from the dispenser. Suture material in so-called suture dispensers is predominantly used in veterinary medicine. The packaging is safe and economical.

Ligatu-Pack Ligature-Pack

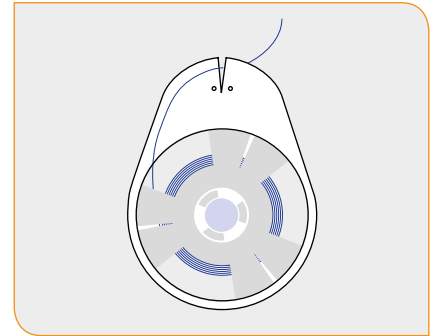

Chirurgisches Nahtmaterial bis zu einer Länge von 400 cm kann während der Operation von einer Handrolle entnommen werden.

Suture material of up to 4 m in length can be taken from a hand reel during an operation.

Organisationshilfen / *Organizational support*

1. Set-Verpackung

Individuelle Zusammenstellung verschiedener Nahtmaterialien in einem Set nach Ihren indikationsspezifischen Vorgaben über Material, Menge und Reihenfolge.

- Mindestabnahme: produktionsbedingt
- Fertigung ohne Aufpreis
- Beschriftung mit allen relevanten Angaben (Indikation, Inhalt, ...)
- Eine LOT-Nr. für gesamtes Set

1. Set packs

Individually tailored combinations of various suture materials in accordance with your indication specific instructions regarding material, amount, and sequence.

- *Minimum purchase: due to production*
- *Prepared at no additional charge*
- *Lettering with all necessary data (indication, content, ...)*
- *Only one LOT-no. for the whole set*

2. Sonderkombinationen

Sollten Sie eine Kombination benötigen, die Sie nicht in unserem Katalog finden, fertigen wir diese ohne Aufpreis nach Ihren individuellen Anforderungen, sofern dieses technisch machbar ist. Bitte beachten Sie die längere Lieferzeit sowie eine produktionsbedingte Mindestabnahme (Umtausch ausgeschlossen).

2. Special orders

Should you require a combination that does not feature in our catalogue, we will prepare it for you according to individually needs at no additional price provided that it is technically possible to do so. Please note that delivery times are longer than with standard orders and that there is no exchange possible.

3. Kombi-Box

Das Aufbewahrungsmagazin für Standard-Nahtmaterialpackungen zur übersichtlichen Organisation im OP (horizontal / vertikal zusammensteckbar).

3. Combination Box

The container for storing standard packs of suture materials provides easy access to suture materials in the operating theatre (horizontally and vertically attachable).

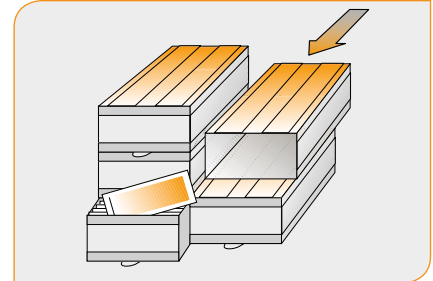
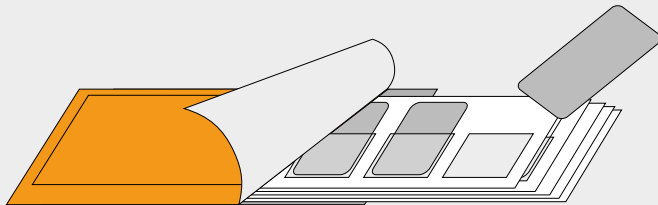











Fadentabelle / Suture table

Ph.-Eur.	Durchmesser- spanne in mm Diameter range in mm	PGA RESORBA®	PGA resosquick™	MOPYLEN®	RESOPREN®	POLYESTER	SUPOLENE	NYLON monofil NYLON monofilament	RESOLON®	SUPRAMID	SEIDE SILK	STAHLDRAHIT monofil STEEL monofilament	Synth. monofile Durchm. spanne in mm Diameter range in mm	GLYCOLON®	PDO RESORBA™
0.1 EP	0,010-0,019	-	-	-	-	-	-	-	-	-	-	-	-	-	-
0.2 EP	0,020-0,029	-	-	10-0	-	-	-	10-0	-	-	10-0	-	-	-	-
0.3 EP	0,030-0,039	-	-	9-0	-	-	-	9-0	-	-	9-0	-	-	-	-
0.4 EP	0,040-0,049	8-0	8-0	8-0	-	-	-	8-0	-	-	8-0	-	-	-	-
0.5 EP	0,050-0,069	7-0	7-0	7-0	7-0	-	-	7-0	7-0	-	7-0	-	0,050-0,094	-	7-0
0.7 EP	0,070-0,099	6-0	6-0	6-0	6-0	6-0	6-0	6-0	6-0	6-0	6-0	-	0,096-0,149	6-0	6-0
1 EP	0,100-0,149	5-0	5-0	5-0	5-0	5-0	5-0	5-0	5-0	5-0	5-0	5-0	0,150-0,199	5-0	5-0
1.5 EP	0,150-0,199	4-0	4-0	4-0	4-0	4-0	4-0	4-0	4-0	4-0	4-0	4-0	0,200-0,249	4-0	4-0
2 EP	0,200-0,249	3-0	3-0	3-0	3-0	3-0	3-0	3-0	3-0	3-0	3-0	3-0	0,250-0,339	3-0	3-0
2.5 EP	0,250-0,299	-	2-0	-	-	-	-	-	-	2-0	-	-	-	-	-
3 EP	0,300-0,349	2-0	2-0	2-0	2-0	2-0	2-0	2-0	2-0	2-0	2-0	2-0	0,340-0,399	2-0	2-0
3.5 EP	0,350-0,399	0	0	0	0	0	0	0	0	0	0	0	0,400-0,499	0	0
4 EP	0,400-0,499	1	1	1	1	1	1	1	1	1	1	1	0,500-0,570	1	1
5 EP	0,500-0,599	2	2	2	2	2	2	2	-	2	2	2	0,571-0,610	-	2
6 EP	0,600-0,699	3+4	3+4	-	-	3+4	3+4	-	-	-	3+4	3+4	-	-	-
7 EP	0,700-0,799	5	5	-	-	5	-	-	-	-	5	5	-	-	-
8 EP	0,800-0,899	-	-	-	-	6	-	-	-	-	-	6	-	-	-
9 EP	0,900-0,999	-	-	-	-	7	-	-	-	-	-	7	-	-	-
10 EP	1,000-1,099	-	-	-	-	8	-	-	-	-	-	-	-	-	-

Wussten Sie schon? / Do you know?

Kleine Symbollehre für Medizinprodukte
Short lesson in symbols used for medical products

	Bestellnummer	Reference number
	Chargenbezeichnung	Batch number
	Verwendbar bis Jahr - Monat - Tag	Use by year - month - day
	Gebrauchsanweisung beachten	Consult instructions for use
	Nicht zur Wiederverwendung	Do not reuse
	Nicht erneut sterilisieren	Do not resterilize
	Bei beschädigter Verpackung nicht verwenden	Do not use if package is damaged
	Sterilisation mit Ethylenoxid	Sterilised using ethylene oxide
	Obere Temperaturbegrenzung	Upper Limit of Temperature
	CE-Kennzeichnung und Kennnummer der benannten Stelle. Das Produkt entspricht den grundlegenden Anforderungen der Richtlinie des Rates über Medizinprodukte 93/42/EWG	CE mark and identification Number of the Notified Body. Product conforms to the essential requirements of the Medical Device Directive 93/42/EEC
	HIBC-Code	HIBC-Code

Symbolerklärungen zur Chemischen Zusammensetzung synthetischen Nahtmaterials
Explanation of symbols used for the chemical composition of synthetic sutures

PGA-PCL	GLYCOLON®	Poly(Glycolide-Co-Caprolactone)	Poly(glycolide-co-caprolactone)
PGA	PGA <i>resoquick</i> ™	Polyglykolsäure	Polyglycolic acid
PGA	PGA <i>RESORBA</i> ®	Polyglykolsäure	Polyglycolic acid
PDO	PDO <i>RESORBA</i> ™	Poly(P-Dioxanon)	Poly(p-dioxanone)
PP	MOPYLEN®	Polypropylen	Polypropylene
PVDF	RESOPREN®	Polyvinylidendifluorid	Polyvinylidene difluoride
PET	POLYESTER	Polyester	Polyester
PET	SUPOLENE	Polyester	Polyester
PA	NYLON	Polyamid	Polyamide
PA	RESOLON®	Polyamid	Polyamide
PA	SUPRAMID	Polyamid	Polyamide

Symbolerklärungen / Explanation of Symbols





	Abziehnadel <i>control release needle</i>		Schlingennaht <i>loop suture</i>
	Schlinge <i>loop</i>		Ligaturpack/-spule <i>ligature pack</i>

Materialsymbole auf der Verpackung

Symbols used on packaging







Resorbierbares Nahtmaterial

absorbable suture material

	gefärbt / geflochten / beschichtet / resorbierbar	<i>dyed / braided / coated / absorbable</i>	PGA RESORBA®
	gefärbt / monofil / resorbierbar	<i>dyed / monofilament / absorbable</i>	PDO RESORBA™, GLYCOLON®
	ungefärbt / geflochten / beschichtet / resorbierbar	<i>undyed / braided / coated / absorbable</i>	PGA RESORBA®, PGA resoquick™
	ungefärbt / monofil / resorbierbar	<i>undyed / monofilament / absorbable</i>	PDO RESORBA™, GLYCOLON®

Nicht-resorbierbares Nahtmaterial

non-absorbable suture material

	gefärbt / geflochten / beschichtet / nicht-resorbierbar	<i>dyed / braided / coated / non-absorbable</i>	SUPOLENE, SEIDE SILK
	gefärbt / geflochten / nicht-resorbierbar	<i>dyed / braided / non-absorbable</i>	POLYESTER
	gefärbt / gezwirnt / beschichtet / nicht-resorbierbar	<i>dyed / twisted / coated / non-absorbable</i>	SUPRAMID
	gefärbt / monofil / nicht-resorbierbar	<i>dyed / monofilament / non-absorbable</i>	MOPYLEN®, RESOPREN®, NYLON, SUPRAMID, RESOLON®
	ungefärbt / geflochten / beschichtet / nicht-resorbierbar	<i>undyed / braided / coated / non-absorbable</i>	SUPOLENE, SEIDE SILK
	ungefärbt / geflochten / nicht-resorbierbar	<i>undyed / braided / non-absorbable</i>	POLYESTER
	ungefärbt / gezwirnt / beschichtet / nicht-resorbierbar	<i>undyed / twisted / coated / non-absorbable</i>	SUPRAMID
	ungefärbt / monofil / nicht-resorbierbar	<i>undyed / monofilament / non-absorbable</i>	NYLON, SUPRAMID STAHLDRAHT STAINLESS STEEL

Tipps (Warnhinweise) / Suggestions

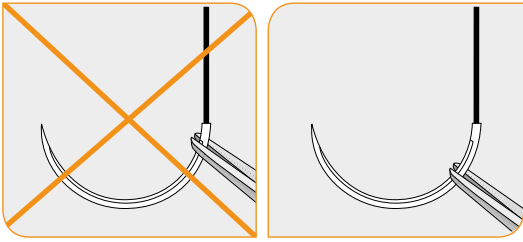

Nadel fassen

Die Nadeln sollen in einer Distanz von ca. 3/4, von der Nadelspitze aus gesehen, gefasst werden. Nicht an der Armierungszone fassen, damit diese und auch der Faden nicht verletzt werden.

Holding the needle

Needles should be held approx. 3/4 away from the tip. Do not clamp where the suture is swaged to the needle to avoid weakening the needle and suture.

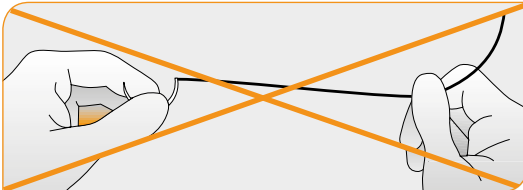

Faden strecken

Faden nach Herausnahme vorsichtig strecken! Nicht schnell ziehen oder reiben; nicht an der Nadel fassen und strecken!

Straightening the suture

Straighten the suture gently after removal. Do not rub it or pull it quickly. Do not hold the needle and stretch!

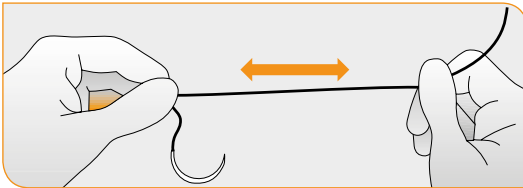

Die Nadel / The needle

Dürfen wir vorstellen: Die chirurgische Nadel!
May we introduce: The surgical needle!

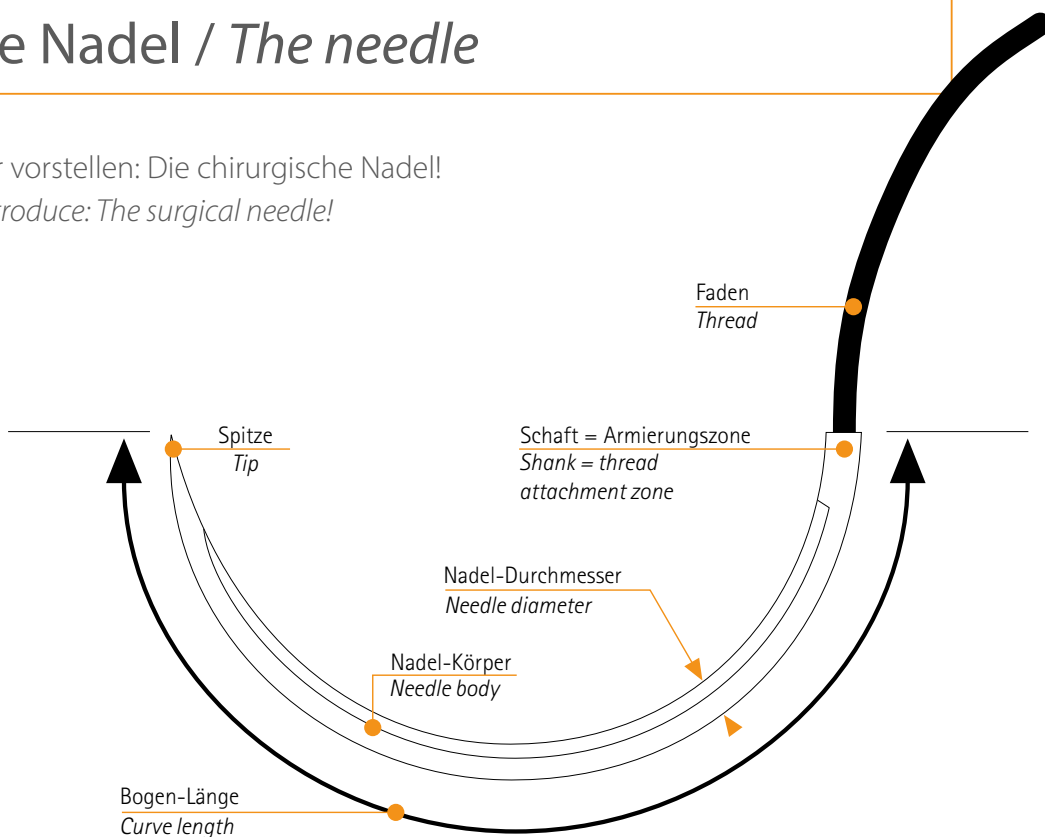

Nadelcode / Needle code

<p>H</p> <p>R</p> <p>X</p> <p>30</p>	<p>1. Buchstabe: Gibt die Nadelkrümmung an</p> <p>F = 5/8-kreisförmig H = 1/2-kreisförmig D = 3/8-kreisförmig V = 1/4-kreisförmig K = 1/2-kreis/kufenförmig A = Asymptotisch G = Gerade</p>	<p>1st letter: Indicates the curvature of the needle</p> <p>F = 5/8 circle H = 1/2 circle D = 3/8 circle V = 1/4 circle K = semicurved A = asymptotic G = straight</p>
	<p>2. Buchstabe: Gibt Auskunft über die Ausführung des Nadelkörpers und der Spitze</p> <p>R = Rundkörper-Nadel S = Schneidende Nadel (außen)</p>	<p>2nd letter: Gives information on the type of needle and needle tip</p> <p>R = round bodied needle S = reverse cutting needle</p>
	<p>3.+4. Buchstabe: Bezeichnet die Sonderformen des Nadelkörpers und der Spitze</p> <p>I = innen schneidend M = PREMIUM-Schliff (z.T. Handschliff) N = Stumpfe Spitze T = Schneidende Spitze (DIAMOND) P = Spatula-Nadel (PREMIUM/DIAMOND) S = stärkerer Durchmesser X = extra starker Durchmesser F = feiner PREMIUM-Schliff "THIN LINE" (z.T. Handschliff) W = biegsame Nadel</p>	<p>3rd and 4th letters: describe special features of the needle and needle tip</p> <p>I = conventional cutting M = PREMIUM cut (partly hand-honed) N = blunt point T = trocar point P = spatulated needle S = stronger diameter X = extra strong diameter F = thin PREMIUM cut "THIN LINE" (partly hand-honed) W = flexible needle</p>
	<p>Zahlen geben gestreckte Länge der Nadel (Bogenlänge) in Millimeter an</p> <p>S (nach Zahlen) = stärkerer Durchmesser F (nach Zahlen) = extra feiner Durchmesser</p>	<p>Numbers indicate the straight (extended) length of the needle in millimetres</p> <p>S (after numbers) = stronger diameter F (after numbers) = extra thin diameter</p>

Nadelkrümmung / Needle curvature

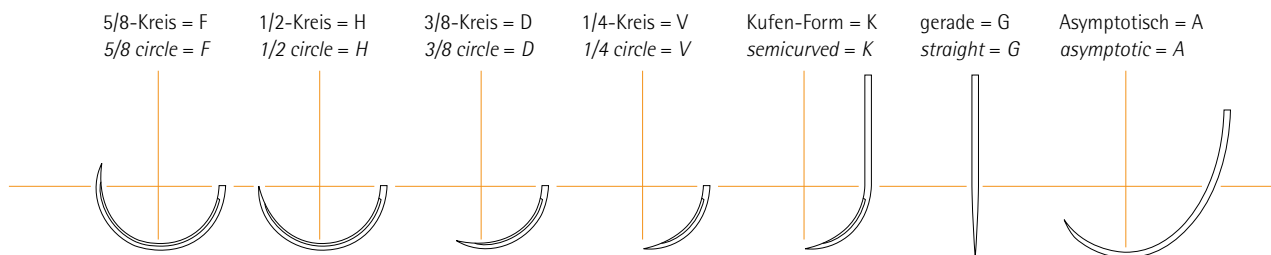

Nadelformen / Needle shapes

1. Spatula Nadel ◻ = P

1/2-, 3/8-, 1/4-kreisförmig oder gerade = HSPM, DSPM, VSPM

- Für Augen- und Mikrochirurgie
- Abgeflachter Nadelkörper
- PREMIUM-Schliff
- Seitlich schneidend

1. Spatula needle ◻ = P

1/2 circle, 3/8 circle, 1/4 circle, or straight = HSPM, DSPM, VSPM

- For use in ophthalmic surgery and microsurgery
- Needle cross-section flattened
- PREMIUM cut
- Cuts on lateral edges



2. Stumpfe Rundkörpernadel ○ = RN

1/2-, 3/8- kreisförmig oder 1/2-gebogen = HRN, DRN, KRN

- Für Parenchymgewebe, Cervix und Muskelzüge am Auge
- Stumpfe Nadelspitze
- Kein Durchstechen von Gefäßen oder Sehnen

2. Blunt round-bodied needle ○ = RN

1/2 circle, 3/8 circle or semicurved = HRN, DRN, KRN

- For use in parenchymal tissue, the cervix, and muscle traction in the eye
- Needle tip blunt
- No puncturing of vessels or tendons



3. Außen schneidende Nadel ▼ = S

1/2-, 3/8-kreisförmig, 1/2-gebogen oder gerade = HS, DS, KS, GS

- Für festes Gewebe, wie z.B. Haut
- Dreieckiger Nadelquerschnitt
- z.T. mit PREMIUM-Schliff M

3. Reverse cutting needle ▼ = S

1/2 circle, 3/8 circle, semicurved or straight = HS, DS, KS, GS

- For use in firm tissue such as skin
- Triangular needle cross-section
- Also available with PREMIUM cut needles M

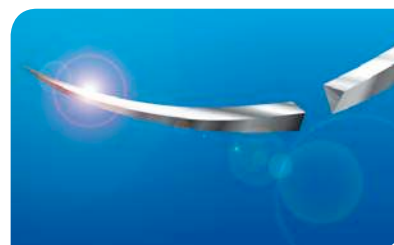

4. Innen schneidende Nadel ▲ = SI

1/2-, 3/8-kreisförmig = HSI, DSI, FSI

- Für festes Gewebe, wie z.B. Haut
- Dreieckiger Nadelquerschnitt
- z.T. mit PREMIUM-Schliff M

4. Inner cutting needle ▲ = SI

1/2 circle, 3/8 circle = HSI, DSI, FSI

- For use in firm tissue such as skin
- Triangular needle cross-section
- Also available with PREMIUM cut needles M



5. Rundkörpernadel ● = R

5/8-, 1/2-, 3/8-kreisförmig oder gerade = FR, HR, DR, GR

- Für weiches Gewebe (subcutan), wie Muskel, Faszie, Schleimhaut
- Zum besseren Sitz des Nadelhalters ist der Nadelkörper im mittleren Bereich abgeflacht
- Leichter Einstich

5. Round-bodied needle ● = R

5/8 circle, 1/2 circle, 3/8 circle or straight = FR, HR, DR, GR

- For use in soft tissue (subcutaneous) such as muscle, fascia, mucosa
- In order to improve grip by the needle holder, the cross-section of the middle part of the needle is flattened
- Easy insertion

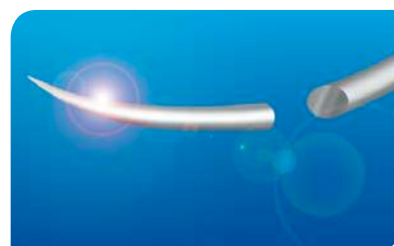

6. Schneidende Rundkörpernadel

◻ = RT

1/2-, 3/8-kreisförmig oder gerade = HRT, DRT, GRT, ART

- Für festes Gewebe, sklerotische Gefäße und Prothesen
- Nadelspitze dreikantig geschliffen

6. Round-bodied cutting needle

◻ = RT

1/2 circle, 3/8 circle or straight = HRT, DRT, GRT, ART

- For use in firm tissue, sclerotic vessels, and implants
- Needle tip triangular in section



Nadelfolie / Needle foil

Zur Identifizierung atraumatischer Nadeln

Die Nadelfolie erleichtert die Einordnung von chirurgischen Nadeln hinsichtlich Länge und Form. Legen Sie die Folie des Nadelprogramms über die zu bestimmende Nadelab- bildung und lesen Sie die technischen Daten über den europäischen Nadelcode ab.

Foil for identifying atraumatic needles

The foil enables the length and shape of any needle to be identified. Place the foil showing the range of needles over the needle you like to identify and read off the corresponding technical data and European code.

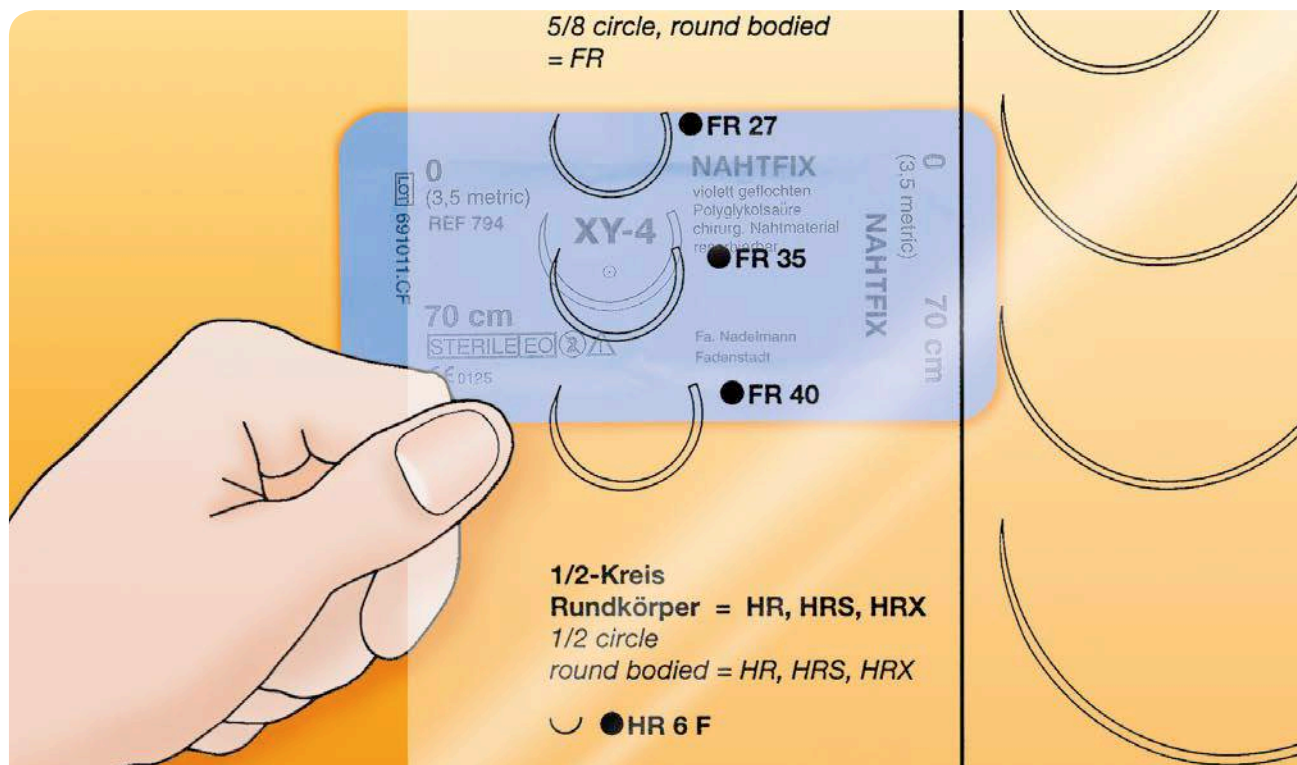

Nadel-Programm / Needle range

FR = 5/8-Kreis Rundkörper
FR = 5/8 circle, taper point

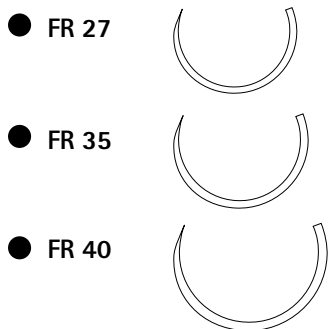

HR, HRS, HRX = 1/2-Kreis Rundkörper
HR, HRS, HRX = 1/2 circle, taper point

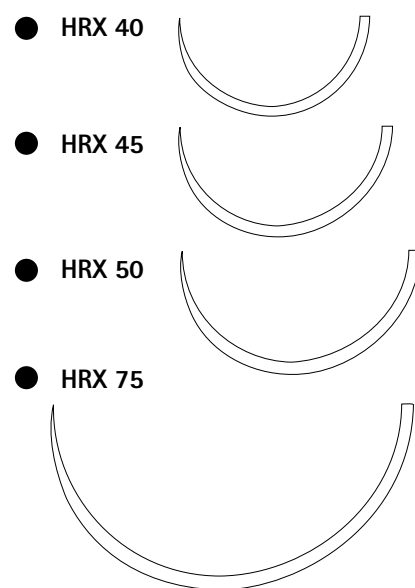
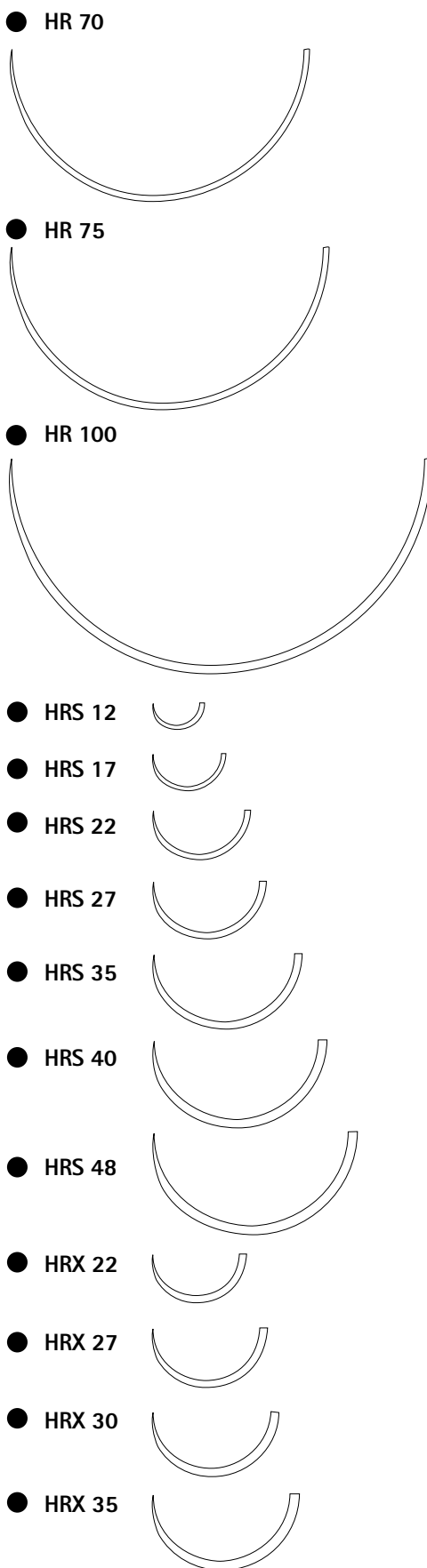
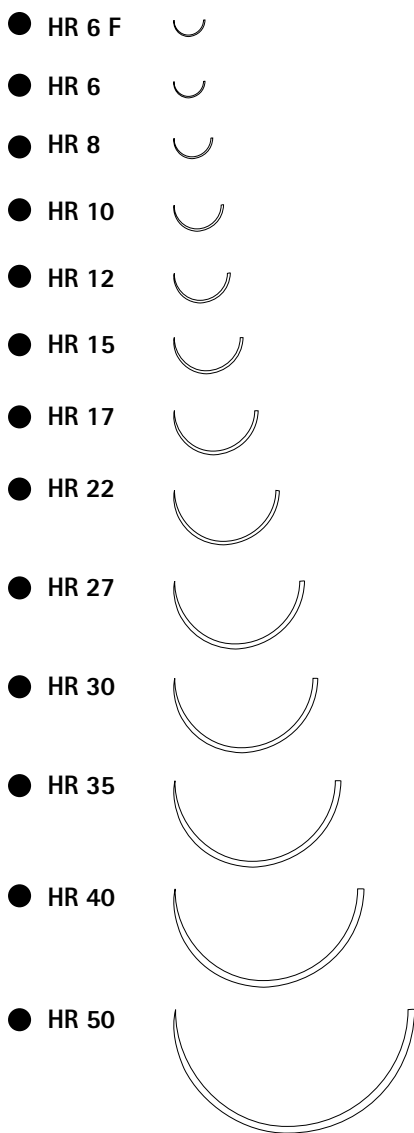

HRN = 1/2-Kreis Rundkörper stumpf
HRN = 1/2 circle, blunt taper point

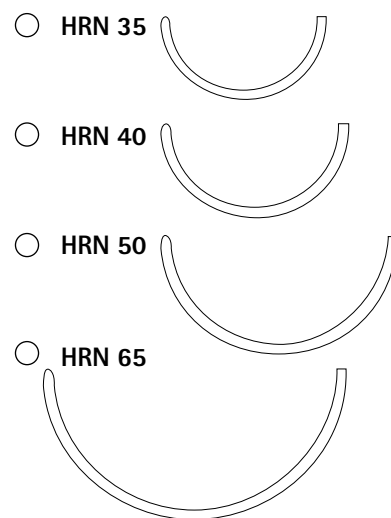



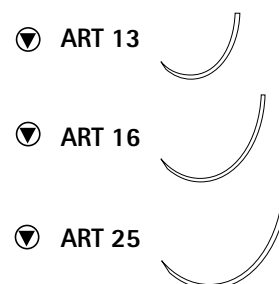









**ART = Asymptotische
 schneidende Rundkörper**
ART = asymptotic, taper cutting



Nadel-Programm / Needle range







HRT, HRTX = 1/2-Kreis schneidende Rundkörper (Diamond-Spitze)







HRT, HRTX = 1/2 circle, taper cutting

- ▼ HRT 13 
- ▼ HRT 16 
- ▼ HRT 18 
- ▼ HRT 22 
- ▼ HRT 25 
- ▼ HRT 30 
- ▼ HRT 35 
- ▼ HRT 40 
- ▼ HRT 45 
- ▼ HRT 50 
- ▼ HRTX 45 
- ▼ HRTX 50 

DR = 3/8-Kreis Rundkörper



DR = 3/8 circle, taper point

- DR 4 
- DR 5 F 
- DR 5 
- DR 6 
- DR 8 
- DR 10 F 

- DR 10 
- DR 12 F 
- DR 12 
- DR 18 
- DR 20 
- DR 30 







DRN = 3/8-Kreis Rundkörper stumpf

DRN = 3/8 circle, blunt taper point

- DRN 17 
- DRN 64 & 65 

DRT = 3/8-Kreis schneidende Rundkörper (Diamond-Spitze), DRTM = mit PREMIUM-Schliff

DRT = 3/8 circle, taper cutting, DRTM = with PREMIUM cut

- ▼ DRT 12 
- ▼ DRT 18 
- ▼ DRT 25 
- ▽ DRTM 5 
- ▽ DRTM 6 
- ▽ DRTM10 
- ▽ DRTM 12 

Nadel-Programm / Needle range

HS = 1/2-Kreis außen schneidend
HS = 1/2 circle, reverse cutting

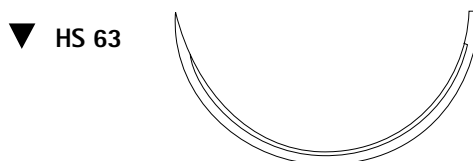
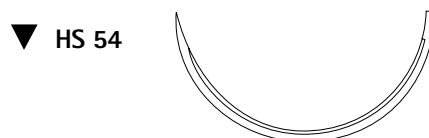
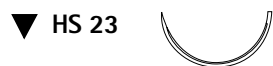
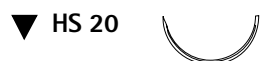
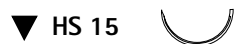
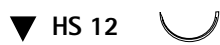

Nadel-Programm / Needle range

HSX = 1/2-Kreis außen schneidend, extra stark

HSX = 1/2 circle, reverse cutting, extra strong



HSM = 1/2-Kreis außen schneidend mit PREMIUM-Schliff

HSM = 1/2 circle, reverse cutting, with PREMIUM cut

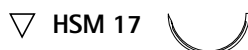
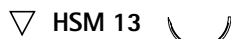
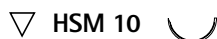
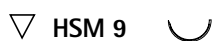
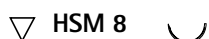

**DS = 3/8-Kreis außen schneidend
DSM = mit PREMIUM-Schliff**

*DS = 3/8 circle, reverse cutting
DSM = PREMIUM cut*

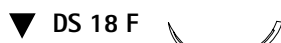
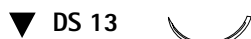

**PREMIUM-Schliff
PREMIUM cut**

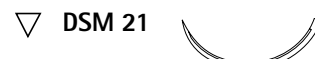
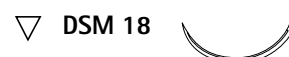
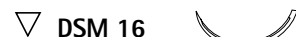
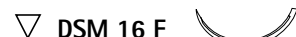
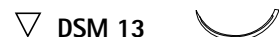
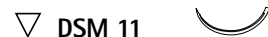
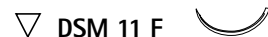
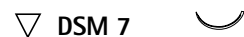
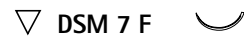
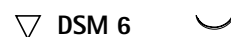
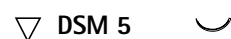

DSI = 3/8-Kreis innen schneidend

DSI = 3/8 circle, inner cutting

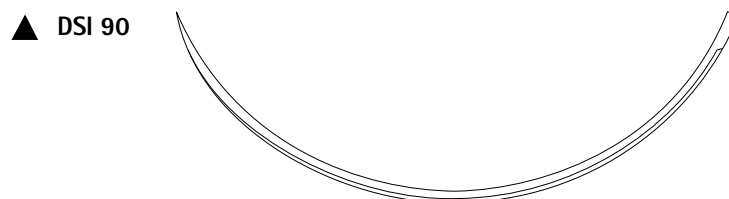

Nadel-Programm / Needle range

GR = Gerade Rundkörper

GR = straight, taper point

● GR 20

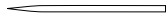

● GR 22

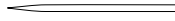

● GR 45



● GR 51



● GR 65

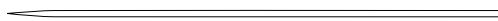

● GRW 65



biegsame Nadel / flexible needle

GRT = Gerade schneidende Rundkörper (Diamond-Spitze)

GRT = straight, taper cutting

▼ GRT 40



GS = Gerade schneidend

GS = straight, cutting

▼ GS 12



▼ GS 25



▼ GS 45



▼ GS 50



▼ GS 60



GSPM = Gerade SPATULA (PREMIUM-Schliff)

GSPM = straight, spatulated
(PREMIUM cut)

▽ GSPM 16



HSPM = 1/2-Kreis SPATULA (PREMIUM-Schliff)

HSPM = 1/2 circle, spatulated
(PREMIUM cut)

▽ HSPM 5 P (progressive Kurve) (progressive curve)



DSPM = 3/8-Kreis SPATULA (PREMIUM-Schliff)

DSPM = 3/8 circle, spatulated
(PREMIUM cut)



VSPM = 1/4-Kreis SPATULA (PREMIUM-Schliff)

VSPM = 1/4 circle, spatulated
(PREMIUM cut)



KS = 1/2-gebogene außen schneidend

KS = 1/2 curved, reverse cutting



Materialtabelle / Table of materials

Bezeichnung Trade name	Grundstoff Raw material	Struktur Structure	Fadenstärke Thread diameter metric	Fadenstärke Thread diameter USP	Farbe Colour	Resorptionsprofil Absorption profile
PGA <i>resoquick</i> ™	Polyglykolsäure, beschichtet <i>Polyglycolic acid, coated</i>	multifil/geflochten <i>multifilament/braided</i>	0.4 bis/to 7 metric	USP 8-0 bis/to 5	ungefärbt <i>undyed</i>	kurzfristig <i>short term</i>
GLYCOLON®	Polyglykolsäure-Caprolacton <i>Polyglycolic acid-caprolactone</i>	monofil <i>monofilament</i>	0.7 bis/to 4 metric	USP 6-0 bis/to 1	violett, ungefärbt <i>violet, undyed</i>	kurzfristig <i>short term</i>
PGA <i>RESORBA</i> ®	Polyglykolsäure, beschichtet <i>Polyglycolic acid, coated</i>	multifil/geflochten <i>multifilament/braided</i>	0.4 bis/to 7 metric	USP 8-0 bis/to 5	violett, ungefärbt <i>violet, undyed</i>	mittelfristig <i>mid term</i>
PDO <i>RESORBA</i> ™	Polyester Poly (P-Dioxanon) <i>Polyester poly (p-dioxanone)</i>	monofil <i>monofilament</i>	0.5 bis/to 5 metric	USP 7-0 bis/to 2	violett, ungefärbt <i>violet, undyed</i>	langfristig <i>long term</i>
MOPYLEN®	Polypropylen <i>Polypropylene</i>	monofil <i>monofilament</i>	0.2 bis/to 5 metric	USP 10-0 bis/to 2	blau <i>blue</i>	
RESOPREN®	PVDF	monofil <i>monofilament</i>	0.5 bis/to 5 metric	USP 7-0 bis/to 2	blau <i>blue</i>	
POLYESTER	Polyester	multifil/geflochten <i>multifilament/braided</i>	0.7 bis/to 10 metric	USP 6-0 bis/to 8	grün, weiß <i>green, white</i>	
SUPOLENE	Polyester, beschichtet <i>Polyester, coated</i>	multifil/geflochten <i>multifilament/braided</i>	0.7 bis/to 6 metric	USP 6-0 bis/to 4	grün, weiß <i>green, white</i>	
NYLON RESOTEX® ORAL	Polyamid <i>Polyamide</i>	monofil <i>monofilament</i>	0.2 bis/to 5 metric 0.5 bis/to 1.5 metric	USP 10-0 bis/to 2 USP 7-0 bis/to 4-0	schwarz, weiß <i>black, white</i>	
RESOLON®	Polyamid <i>Polyamide</i>	monofil <i>monofilament</i>	0.5 bis/to 4 metric	USP 7-0 bis/to 1	blau <i>blue</i>	
SUPRAMID	Polyamid <i>Polyamide</i>	pseudomonofil <i>pseudomonofilament</i>	0.7 bis/to 5 metric	USP 6-0 bis/to 2	schwarz, weiß <i>black, white</i>	
SEIDE SILK	Seidenfibroin <i>Silk fibroin</i>	multifil/geflochten <i>multifilament/braided</i>	0.2 bis/to 7 metric	USP 10-0 bis/to 5	schwarz, weiß <i>black, white</i>	
STAHLDRAHT STAINLESS STEEL	Stahldraht <i>Stainless steel</i>	monofil <i>monofilament</i>	1 bis/to 9 metric	USP 5-0 bis/to 7	natur <i>nature</i>	

Resorption / Absorption

Resorbierbare Nahtmaterialien

adaptieren das Gewebe während der Heilungsphase und verlieren dabei zunehmend ihre Zugfestigkeit und Reißkraft. Resorbierbares Nahtmaterial wird durch körpereigene proteolytische Enzyme oder durch Hydrolyse (bei PGA RESORBA®, PGA resoquick™, PDO RESORBA™ und GLYCOLON®) abgebaut.

Nicht-resorbierbares Nahtmaterial

bleibt bei versenkten Nähten im Körpergewebe nahezu unverändert und wird vom Organismus in das umliegende Gewebe eingebaut (abgekapselt). Das für Hautnähte angewandte Fadenmaterial wird, sobald die Festigkeit des Narbengewebes die Wundränder ausreichend zusammenhält, vom Arzt entfernt (üblich nach 7-14 Tagen). Innerhalb des Abbauprozesses unterscheidet man folgende Stadien:

Resorptionszeit

Zeit, in der der Faden 50 % seiner Knotenreißkraft verliert.

Massenresorption

Zeitraum bis zur völligen Auflösung des Fadenmaterials im Gewebe.

Verfallszeit

Zeit, in der ein grundsätzlich nicht-resorbierbares Fadenmaterial durch Degradation in (kleinere) Bruchstücke

zerfällt und somit gleichfalls an Festigkeit verliert (z.B. Polyamide).

Resorptionseigenschaften

Unterschiedliche Indikationen erfordern auch ein unterschiedliches Reißkraft- und Resorptionsverhalten. Diese definierten Fadeneigenschaften können durch die Wahl des Materials sowie modifizierte Herstellungsprozesse erreicht werden. Neben dem kurz-, mittel- oder langfristigen Reißkraftverlust erfolgt auch die entsprechende zeitlich bestimmte Resorption. Das Fadenmaterial erfüllt seine eigentliche Aufgabe nur, solange die gewünschte Reißkraft vorhanden ist.

Absorbable sutures

approximate the tissues during the healing process. During this time the suture's tensile strength will gradually diminish. Absorbable suture material is metabolised by endogenous proteolytic enzymes or by hydrolysis (in the case of PGA RESORBA®, PGA resoquick™, PDO RESORBA™ and GLYCOLON®).

Non-absorbable sutures

remain almost unchanged when placed within body tissues and is encapsulated within the wound scar tissue by the organism. The sutures used for skin closure are removed once the scar tissue has become sufficiently firm to

hold the wound edges together (usually after 7 – 14 days).

It has to be distinguished as follows:

Absorption time

The period in which the suture loses 50 % of its knot tensile strength.

Disintegration

The period during which essentially non-absorbable suture break down by degradation into (smaller) pieces and thus losing its strength (e.g. polyamide).

Dissolution

The period during which the suture completely dissolves within the tissue.

Characteristics of absorption

Different indications also require different tensile strengths and absorption characteristics. These particular features of different sutures can be achieved by the choice of the material and modifying the production process. In addition to the immediate, moderately quick or delayed loss of tensile strength there is also the corresponding duration of absorption. Any given thread material can only fulfil its purpose as long as it has the desired tensile strength.

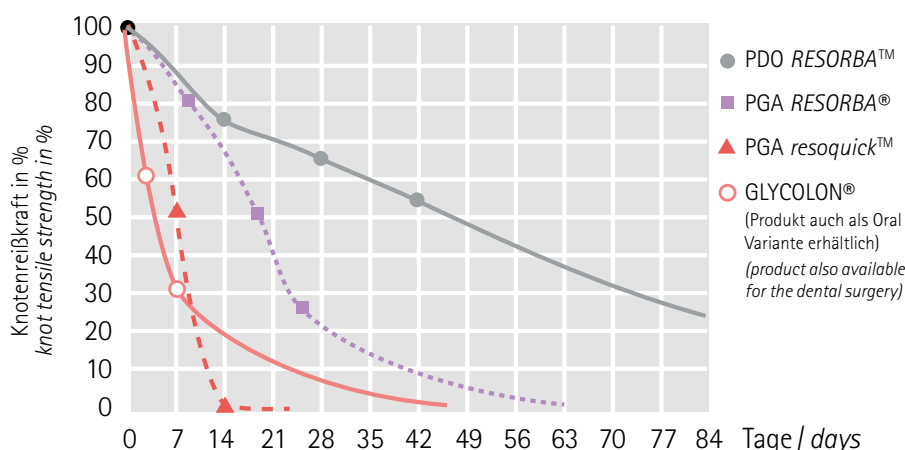

In-vitro-Degradationsversuch: Messung der Knotenreißkraft von GLYCOLON®, PGA resoquick™, PGA RESORBA® und PDO RESORBA™. Nahtmaterial der Stärke 3-0 USP bzw. 2 metric.

In-vitro trial of suture degradation by measuring the knot tensile strengths of GLYCOLON®, PGA resoquick™, PGA RESORBA® and PDO RESORBA™. Suture size: 3-0 USP (2 metric).



- kurzfristig resorbierbares Multifilament
- hohe Reißkraft
- minimales Gewebetrauma
- glatter Gewebedurchzug
- guter Knotensitz

- *short term absorbable multifilament*
- *high tensile strength*
- *minimized tissue trauma*
- *smooth tissue passage*
- *perfect knot security*

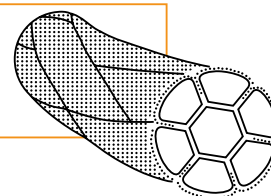

Eigenschaften:

- sehr geschmeidig
- hohe Reißkraft
- guter Knotensitz
- atraumatischer Gewebedurchzug
- moderate Gewebereaktion

PGA resoquick™ ist ein lineares Homopolymer der Glykolsäure (Hydroxyessigsäure) mit hohem Molekulargewicht, das zu Fäden extrudiert und zu Nähten verschiedener Durchmesser geflochten wird. Die Metabolisierung des PGA-Fadenmaterials im Gewebe erfolgt durch die Aufnahme von Wasser, sodass die Synthese umgekehrt wird. Die monomere Glykolsäure wird durch

den normalen Stoffwechsel mittels Enzymen in CO₂ und H₂O gespalten. Die feinen, präzisionsgeflochtenen Fäden gewähren eine sehr hohe Reißfestigkeit sowie ausgezeichnete Handlingeigenschaften. Die spezielle Beschichtung aus einem Gemisch aus Kalziumstearat und Polycaprolacton überzieht die Faserbündel in einer dünnen Schicht, sodass die Oberflächenreibung verringert wird. Resorbierbare Nahtmaterialien adaptieren das Gewebe während der Heilungsphase und verlieren dabei zunehmend ihre Zugfestigkeit und Reißkraft. Die präzisionsgeflochtenen Fäden aus Polyglykolsäure, aus denen PGA resoquick™ besteht, gewährleisten eine standardisierte und mäßig schnelle Resorption im Gewebe. PGA resoquick™ wird schneller als PGA RESORBA® resorbiert, da dieses Material unter Verwendung eines PGA-Materials mit niedrige-

rem Molekulargewicht hergestellt wird. Das Molekulargewicht des PGA-Materials wird während eines speziellen Wärmebehandlungsprozesses des Fadens verringert, bevor die Beschichtung aufgetragen wird. Nach nur sieben Tagen hat PGA resoquick™ bereits 50 % seiner ursprünglichen Reißkraft verloren. Nach 14 Tagen ist keine messbare Reißkraft mehr vorhanden. Die Resorption von PGA resoquick™ ist nach ca. 42 Tagen abgeschlossen.

- ➔ Farbe: ungefärbt oder violett
- ➔ Chemische Bezeichnung: Polyglykolsäure
- ➔ Fadenstärke: USP 8-0 -5 (0.4 - 7 metric)
- ➔ Konfektionsangebote:
 - Nadel-Faden-Kombinationen
 - in vorgeschrittenen Längen
- ➔ Sterilisation: Ethylenoxid

Properties:

- very supple
- very high tensile strength
- minimal tissue reaction
- smooth passage through tissue
- high knot security

PGA resoquick™ is a high molecular weight, linear homopolymer of glycolic acid (hydroacetic acid), which is extruded into thin filaments and braided into sutures of various diameters.

Metabolisation of the PGA suture within the tissue occurs by the uptake of water, thus reversing the











synthesis. The monomeric glycolic acid is split enzymatically into CO₂ and H₂O by the normal metabolism. The fine, precision braided filaments guarantee a very high tensile strength as well as great suppleness. The special coating of a mixture of calcium stearate & polycaprolactone thinly covers the fibre bundles for specific reduction of surface friction. Absorbable suture approximates the tissue during the healing phase and progressively loses its tensile strength and breaking load. The precision braided filaments of polyglycolic acid that make up PGA resoquick™ ensure standardized and moderately rapid absorption in tissue. PGA resoquick™ is absorbed rather quickly than PGA RESORBA® because this material is manufactured using a lower molecular weight

PGA. The molecular weight of the PGA material is reduced during a special heat treatment process of the thread before coating. After only seven days PGA resoquick™ has already lost 50% of its original breaking load. After 14 days all original breaking load is lost completely. Absorption of PGA resoquick™ is approximately completed after 42 days.

- ➔ Colour: violet or undyed
- ➔ Chemical name: polyglycolic acid
- ➔ Thread diameter: USP 8-0 -5 (0.4 - 7 metric)
- ➔ Types of packaging:
 - needle-thread-combinations
 - precut lengths
- ➔ Sterilization method: ethylene oxide





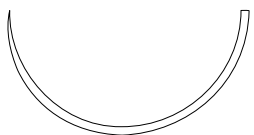

PGA resoquick™

Sterile Nadel-Faden-Kombination / *needle suture combination, sterile*

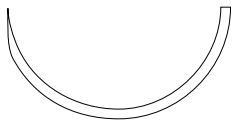
Nadel / needle	Stärke / gauge		Länge / length (m)	Farbe / colour	Best.-Nr. / code no.	Packungsinhalt / box content (Stück / pieces)
	USP	metric				
FR = 5/8-Kreis Rundkörper						
<i>FR = 5/8 circle, taper point</i>						
FR 35 ● 	3-0	2	0,70	ungefärbt / undyed	PRN30104	24
	2-0	3	0,70	ungefärbt / undyed	PRN30103	24
HR, HRS = 1/2-Kreis Rundkörper						
<i>HR, HRS = 1/2 circle, taper point</i>						
HR 17 ● 	5-0	1	0,45	ungefärbt / undyed	PRN30222	24
	5-0	1	0,70	ungefärbt / undyed	PRN30203	24
	4-0	1.5	0,70	ungefärbt / undyed	PRN30204	24
	3-0	2	0,70	ungefärbt / undyed	PRN30205	24
HR 17 F ● 	4-0	1.5	0,70	ungefärbt / undyed	PRN30221	24
HR 22 ● 	4-0	1.5	0,70	ungefärbt / undyed	PRN30208	24
	3-0	2	0,70	ungefärbt / undyed	PRN30209	24
	2-0	3	0,70	ungefärbt / undyed	PRN30210	24
HR 27 ● 	4-0	1.5	0,70	ungefärbt / undyed	PRN30213	24
	3-0	2	0,70	ungefärbt / undyed	PRN30214	24
	2-0	3	0,70	ungefärbt / undyed	PRN30215	24
	0	3.5	0,70	ungefärbt / undyed	PRN30216	24
HRS 27 ● 	2-0	3	0,70	ungefärbt / undyed	PRN30303	24
	0	3.5	0,70	ungefärbt / undyed	PRN30304	24
HR 35 ● 	0	3.5	0,90	ungefärbt / undyed	PRN30217	24
HRS 35 ● 	2-0	3	0,90	ungefärbt / undyed	PRN30308	24
	0	3.5	0,90	ungefärbt / undyed	PRN30309	24
	1	4	0,90	ungefärbt / undyed	PRN30310	24
HRS 40 ● 	0	3.5	0,90	ungefärbt / undyed	PRN30313	24
	1	4	0,90	ungefärbt / undyed	PRN30314	24
HRS 48 ● 	1	4	0,90	ungefärbt / undyed	PRN30317	24
	2	5	0,90	ungefärbt / undyed	PRN30318	24
HR 50 ● 	0	3.5	1,20	ungefärbt / undyed	PRN30219	24
	0	3.5	1,50	ungefärbt / undyed	PRN30218	24



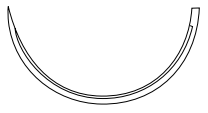







PGA resoquick™

Sterile Nadel-Faden-Kombination / *needle suture combination, sterile*

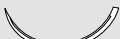
Nadel / needle	Stärke / gauge USP	gauge metric	Länge / length (m)	Farbe / colour	Best.-Nr. / code no.	Packungsinhalt / box content (Stück / pieces)
HRT = 1/2-Kreis schneidende Rundkörper (Diamond-Spitze) <i>HRT = 1/2 circle, taper cutting</i>						
HRT 35 	2-0	3	0,70	ungefärbt / undyed	PRN30612	24
	2-0	3	0,90	ungefärbt / undyed	PRN30608	24
	0	3.5	0,90	ungefärbt / undyed	PRN30609	24
	1	4	0,70	ungefärbt / undyed	PRN30613	24
HRT 45 	2-0	3	0,90	ungefärbt / undyed	PRN30611	24
DRT = 3/8-Kreis schneidende Rundkörper (Diamond-Spitze) <i>DRT = 3/8 circle, taper cutting</i>						
DRT 18 	4-0	1.5	0,70	ungefärbt / undyed	PRN30801	24
HS = 1/2-Kreis außen schneidend <i>HS = 1/2 circle, reverse cutting</i>						
HS 18 	4-0	1.5	0,45	ungefärbt / undyed	PRN31103	24
	3-0	2	0,45	ungefärbt / undyed	PRN31104	24
HS 20 	3-0	2	0,70	ungefärbt / undyed	PRN31117	24
	3-0	2	0,90	ungefärbt / undyed	PRN31115	24
HS 22 	3-0	2	0,45	ungefärbt / undyed	PRN31107	24
	3-0	2	0,70	ungefärbt / undyed	PRN31116	24
	2-0	3	0,45	ungefärbt / undyed	PRN31108	24
HS 40 	1	4	0,90	ungefärbt / undyed	PRN31114	24
DS = 3/8-Kreis außen schneidend DSM = mit PREMIUM-Schliff <i>DS = 3/8 circle, reverse cutting</i> <i>DSM = PREMIUM cut</i>						
DSM 11 	6-0	0.7	0,45	ungefärbt / undyed	PRN31502	24
	6-0	0.7	0,75	ungefärbt / undyed	PRN31527	24
DSM 13 	6-0	0.7	0,45	ungefärbt / undyed	PRN31528	24
	5-0	1	0,45	ungefärbt / undyed	PRN31504	24
	4-0	1.5	0,45	ungefärbt / undyed	PRN31505	24

PGA resoquick™

Sterile Nadel-Faden-Kombination / *needle suture combination, sterile*

Nadel / needle	Stärke / gauge		Länge / length (m)	Farbe / colour	Best.-Nr. / code no.	Packungsinhalt / box content (Stück / pieces)	
	USP	metric					
DS 16 ▼		5-0	1	0,75	ungefärbt / undyed	PRN31428	24
		4-0	1.5	0,70	ungefärbt / undyed	PRN31427	24
DS 18 ▼		5-0	1	0,45	ungefärbt / undyed	PRN31405	24
		4-0	1.5	0,45	ungefärbt / undyed	PRN31426	24
		4-0	1.5	0,75	ungefärbt / undyed	PRN31429	24
		3-0	2	0,45	ungefärbt / undyed	PRN31408	24
DS 18 F ▼		4-0	1.5	0,45	ungefärbt / undyed	PRN31410	24
DSM 18 F ▽ PREMIUM-Schliff / PREMIUM cut		4-0	1.5	0,45	ungefärbt / undyed	PRN31516	24
		4-0	1.5	0,70	ungefärbt / undyed	PRN31517	24
DSM 18 ▽ PREMIUM-Schliff / PREMIUM cut		3-0	2	0,45	ungefärbt / undyed	PRN31510	24
		4-0	1.5	0,70	ungefärbt / undyed	PRN31509	24
		3-0	2	0,70	ungefärbt / undyed	PRN31511	24
DS 24 ▼		3-0	2	0,45	ungefärbt / undyed	PRN31420	24
		2-0	3	0,45	ungefärbt / undyed	PRN31422	24
		3-0	2	0,70	ungefärbt / undyed	PRN31421	24
		2-0	3	0,70	ungefärbt / undyed	PRN31423	24
DSM 24 ▽ PREMIUM-Schliff / PREMIUM cut		3-0	2	0,45	ungefärbt / undyed	PRN31520	24
		2-0	3	0,45	ungefärbt / undyed	PRN31522	24
		3-0	2	0,70	ungefärbt / undyed	PRN31521	24
		2-0	3	0,70	ungefärbt / undyed	PRN31523	24
DS 27 ▼		3-0	2	0,70	ungefärbt / undyed	PRN31424	24
GS = Gerade schneidend GS = straight, cutting							
GS 12 ▼		4-0	1.5	0,45	ungefärbt / undyed	PRN31703	24
DSPM = 3/8-Kreis SPATULA mit PREMIUM-Schliff DSPM = 3/8 circle, spatulated, PREMIUM cut							
2x DSPM 7 ▽ PREMIUM-Schliff / PREMIUM cut		8-0	0.4	0,45	ungefärbt / undyed	PRN3201	24
		7-0	0.5	0,45	ungefärbt / undyed	PRN3202	24

PGA resoquick™

Einzelfadenpackungen, steril in vorgeschrittenen Längen / *Sterile pre-cut suture, non-needed*

Stärke / gauge USP metric		Länge / length (m)	Farbe / colour	Best.-Nr. / code no.	Packungsinhalt / box content (Stück / pieces)
3-0	2	3 x 0,45	ungefärbt / <i>undyed</i>	PWN433	24
2-0	3	3 x 0,45	ungefärbt / <i>undyed</i>	PWN533	24
3-0	2	6 x 0,45	ungefärbt / <i>undyed</i>	PWN465	24
2-0	3	6 x 0,45	ungefärbt / <i>undyed</i>	PWN565	24
2-0	3	2 x 0,70	ungefärbt / <i>undyed</i>	PWN520	24
0	3.5	2 x 0,70	ungefärbt / <i>undyed</i>	PWN620	24
1	4	2 x 0,70	ungefärbt / <i>undyed</i>	PWN720	24
2-0	3	3 x 0,70	ungefärbt / <i>undyed</i>	PWN733	24





- kurzfristig resorbierbares Monofilament
- hohe Reißkraft
- glatter Gewebedurchzug
- minimale Gewebereaktion
- guter Knotensitz

- *short term absorbable monofilament*
- *high tensile strength*
- *smooth tissue passage*
- *minimized tissue trauma*
- *perfect knot security*

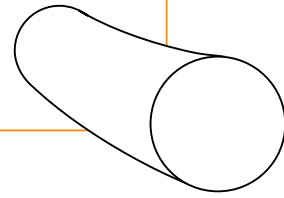

Eigenschaften:

- hohe Reißkraft
- guter Knotensitz
- atraumatischer Gewebedurchzug

Zur Herstellung von GLYCOLON® werden die beiden Materialbestandteile Polyglykolsäure und ϵ -Caprolacton in einem bestimmten Verhältnis copolymerisiert.

Der Abbau des polymeren Fadensmaterials im Gewebe erfolgt durch Wasseraufnahme in Umkehrung der

Synthese. Nach Implantation nimmt die Reißkraft von GLYCOLON® nach 7 Tagen auf 30% ab.

Gewebereaktionen werden zum einen durch die dabei entstehenden unbedenklichen Zwischenprodukte, zum anderen durch die monofile und glatte Oberflächenstruktur des Fadens minimiert.

GLYCOLON® besitzt durch die glatten und monofilen Oberflächenstrukturen des Polymers ausgezeichnete Eigenschaften bezüglich des Handlings und der Gleitfähigkeit.

Gewebetraumatisierungen durch den Fadedurchzug sind bei GLYCOLON® nicht relevant und die monofile Struktur verhindert eine

Dochtwirkung des Fadens ohne zusätzliche Oberflächenbehandlung.

GLYCOLON® ist ungefärbt, besonders für Hautnähte, und violett (mit dem physiologisch unbedenklichen Farbstoff D+C Nr.2) eingefärbt erhältlich.

- ➔ Farbe: ungefärbt oder violett
- ➔ Chemische Bezeichnung: [Poly(Glykolsäure-co- ϵ -Caprolacton)]
- ➔ Fadenstärke: USP 6-0 -1 (0.7-4 metric)
- ➔ Konfektionsangebote:
 - Nadel-Faden-Kombinationen
 - in vorgeschrittenen Längen
- ➔ Sterilisation: Ethylenoxid

Properties:

- high tear resistance
- excellent knot security
- atraumatic tissue passage

The production of GLYCOLON® involves the copolymerisation of polyglycolic acid and ϵ -caprolactone in a certain ratio. The breakdown of the polymeric suture in the tissue occurs through water uptake, thereby reversing the synthesis.

The tear resistance of GLYCOLON® reduces by 30% 7 days after implantation.

The completely safe intermediary products that are formed, as well as the smooth, monofilament surface structure of the thread, result in minimal tissue reaction.

The smooth, monofilament surface structures of the polymer give GLYCOLON® excellent handling and tissue passage properties.







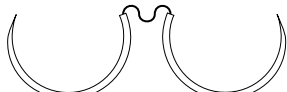
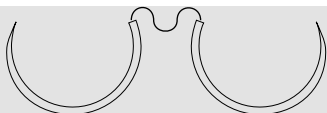

Tissue trauma as a result of suturing is not relevant to GLYCOLON®, and the monofilament structure prevents wicking of the thread without the need for additional surface treatment.

GLYCOLON® is available undyed, especially suitable for skin closure, and in violet (coloured with the physiologically harmless D+C No. 2 dye).

- ➔ Colour: undyed or violet
- ➔ Chemical name: [poly(glycolic acid-co- ϵ -caprolactone)]
- ➔ Thread diameter: USP 6-0 -1 (0.7-4 metric)
- ➔ Types of packaging:
 - needle-thread-combinations
 - precut lengths
- ➔ Sterilization method: ethylene oxide

GLYCOLON®

Sterile Nadel-Faden-Kombination / *needle suture combination, sterile*

Nadel / needle	Stärke / gauge		Länge / length (m)	Farbe / colour	Best.-Nr. / code no.	Packungsinhalt / box content (Stück / pieces)
	USP	metric				
FR = 5/8-Kreis Rundkörper <i>FR = 5/8 circle, taper point</i>						
FR 27 ● 	3-0	2	0,70	violett / violet	PB4012*	24
2 x FR 27 ● 	3-0	2	0,70	violett / violet	PB4011*	24
2 x FR 35 ● 	2-0	3	0,70	violett / violet	PB4010*	24
HR, HRS = 1/2-Kreis Rundkörper <i>HR, HRS = 1/2 circle, taper point</i>						
HR 12 ● 	6-0	0.7	0,45	violett / violet	PB40204	24
	5-0	1	0,45	violett / violet	PB40200	24
HR 17 ● 	5-0	1	0,70	violett / violet	PB40201	24
	4-0	1.5	0,70	violett / violet	PB40202	24
	3-0	2	0,70	violett / violet	PB40203*	24
2 x HR 17 ● 	5-0	1	0,70	violett / violet	PB40207*	24
HR 22 ● 	4-0	1.5	0,70	violett / violet	PB40215	24
	3-0	2	0,70	violett / violet	PB40216	24
	2-0	3	0,70	violett / violet	PB40217	24
2 x HR 22 ● 	4-0	1.5	0,90	violett / violet	PB40227S*	24
HR 27 ● 	4-0	1.5	0,70	violett / violet	PB40230	24
	3-0	2	0,70	violett / violet	PB40231	24
	2-0	3	0,70	violett / violet	PB40232	24
2x HRS 27 ● 	4-0	1.5	0,90	violett / violet	PB40236*	24
2x HR 27 ● 	3-0	2	0,90	violett / violet	PB40239S*	24

*eventuell mit verlängerter Lieferzeit verbunden / *possibly associated with an extended delivery time*

GLYCOLON®











Sterile Nadel-Faden-Kombination / *needle suture combination, sterile*

Nadel / needle	Stärke / gauge USP	metric	Länge / length (m)	Farbe / colour	Best.-Nr. / code no.	Packungsinhalt / box content (Stück / pieces)
HRS 27 ●	0	3.5	0,70	violett / violet	PB40310*	24
	1	4	0,90	violett / violet	PB40313	24
HR 35 ●	2-0	3	0,70	violett / violet	PB40241*	24
	0	3.5	0,70	violett / violet	PB40242*	24
HRS 35 ●	0	3.5	0,90	violett / violet	PB40324*	24
	1	4	0,90	violett / violet	PB40325*	24
HRS 40 ●	0	3.5	0,90	violett / violet	PB40334*	24
	1	4	0,90	violett / violet	PB40335*	24
HRS 48 ●	1	4	0,90	violett / violet	PB40343*	24
HRT = 1/2-Kreis schneidende Rundkörper (Diamond-Spitze) <i>HRT = 1/2 circle, taper cutting</i>						
HRT 16 ▼	5-0	1	0,45	violett / violet	PB40602	24
HRT 18 ▼	4-0	1.5	0,70	violett / violet	PB40605	24
	3-0	2	0,70	violett / violet	PB40606	24
HRT 22 ▼	4-0	1.5	0,70	violett / violet	PB40613*	24
HRT 25 ▼	2-0	3	0,70	violett / violet	PB40620*	24
	2-0	3	0,70	ungefärbt / undyed	PB40621*	24
HS = 1/2-Kreis außen schneidend HSM = mit PREMIUM-Schliff <i>HS = 1/2 circle, reverse cutting HSM = PREMIUM cut</i>						
HSM 9 ▽ PREMIUM-Schliff / PREMIUM cut	6-0	0.7	0,45	violett / violet	PB41201*	24
HS 18 ▼	4-0	1.5	0,70	violett / violet	PB41101*	24

*eventuell mit verlängerter Lieferzeit verbunden / *possibly associated with an extended delivery time*

GLYCOLON®



Sterile Nadel-Faden-Kombination / *needle suture combination, sterile*

Nadel / needle	Stärke / gauge		Länge / length (m)	Farbe / colour	Best.-Nr. / code no.	Packungsinhalt / box content (Stück / pieces)	
	USP	metric					
DS = 3/8-Kreis außen schneidend DSM = mit PREMIUM-Schliff <i>DS = 3/8 circle, reverse cutting</i> <i>DSM = PREMIUM cut</i>							
DSM 11   PREMIUM-Schliff / <i>PREMIUM cut</i>	6-0	0.7	0,45	violett / <i>violet</i>	PB41512	24	
	5-0	1	0,45	violett / <i>violet</i>	PB41501	24	
	6-0	0.7	0,45	ungefärbt / <i>undyed</i>	PB41502	24	
DSM 13   PREMIUM-Schliff / <i>PREMIUM cut</i>	6-0	0.1	0,45	violett / <i>violet</i>	PB41527	24	
	5-0	1	0,45	violett / <i>violet</i>	PB41503	24	
	4-0	1.5	0,45	violett / <i>violet</i>	PB41508	24	
	5-0	1	0,70	violett / <i>violet</i>	PB41507	24	
	6-0	0.7	0,45	ungefärbt / <i>undyed</i>	PB41504	24	
	5-0	1	0,45	ungefärbt / <i>undyed</i>	PB41505	24	
	4-0	1.5	0,45	ungefärbt / <i>undyed</i>	PB41506	24	
	5-0	1	0,70	ungefärbt / <i>undyed</i>	PB41523*	24	
	DSM 16   PREMIUM-Schliff / <i>PREMIUM cut</i>	5-0	1	0,45	violett / <i>violet</i>	PB41509	24
4-0		1.5	0,45	violett / <i>violet</i>	PB41511	24	
5-0		1	0,70	violett / <i>violet</i>	PB41528	24	
5-0		1	0,45	ungefärbt / <i>undyed</i>	PB41524*	24	
4-0		1.5	0,45	ungefärbt / <i>undyed</i>	PB41510	24	
4-0		1.5	0,70	ungefärbt / <i>undyed</i>	PB41525*	24	
DS 18  	5-0	1	0,45	violett / <i>violet</i>	PB41421	24	
	4-0	1.5	0,45	violett / <i>violet</i>	PB41420	24	
	3-0	2	0,45	violett / <i>violet</i>	PB41413	24	
	4-0	1.5	0,70	violett / <i>violet</i>	PB41416	24	
	4-0	1.5	0,45	ungefärbt / <i>undyed</i>	PB41411	24	
	3-0	2	0,45	ungefärbt / <i>undyed</i>	PB41412	24	
	5-0	1	0,70	ungefärbt / <i>undyed</i>	PB41410	24	
	4-0	1.5	0,70	ungefärbt / <i>undyed</i>	PB41414	24	
	3-0	2	0,70	ungefärbt / <i>undyed</i>	PB41415	24	
	5-0	1	0,70	violett / <i>violet</i>	PB41422	24	
	DSM 18   PREMIUM-Schliff / <i>PREMIUM cut</i>	4-0	1.5	0,70	violett / <i>violet</i>	PB41515	24
		3-0	2	0,90	violett / <i>violet</i>	PB41529	24
5-0		1	0,45	ungefärbt / <i>undyed</i>	PB41516	24	
4-0		1.5	0,45	ungefärbt / <i>undyed</i>	PB41513	24	
3-0		2	0,45	ungefärbt / <i>undyed</i>	PB41514	24	
4-0		1.5	0,70	ungefärbt / <i>undyed</i>	PB41522	24	
3-0		2	0,70	ungefärbt / <i>undyed</i>	PB41526*	24	

*eventuell mit verlängerter Lieferzeit verbunden / *possibly associated with an extended delivery time*

GLYCOLON®

Sterile Nadel-Faden-Kombination / *needle suture combination, sterile*

Nadel / needle		Stärke / gauge		Länge / length (m)	Farbe / colour	Best.-Nr. / code no.	Packungsinhalt / box content (Stück / pieces)
		USP	metric				
DS 21 ▼		4-0	1.5	0,70	violett / violet	PB41417	24
DS 24 ▼		3-0	2	0,70	ungefärbt / undyed	PB41418	24
		2-0	3	0,70	ungefärbt / undyed	PB41419	24
DSM 24 ▽ PREMIUM-Schliff / PREMIUM cut		3-0	2	0,70	ungefärbt / undyed	PB41520	24
		2-0	3	0,70	ungefärbt / undyed	PB41521	24

*eventuell mit verlängerter Lieferzeit verbunden / *possibly associated with an extended delivery time*

GLYCOLON®

Einzelfadenpackungen, steril in vorgeschnittenen Längen
Sterile pre-cut suture, non-needled

Stärke / gauge	Länge / length (m)	Farbe / colour	Best.-Nr. / code no.	Packungsinhalt / box content (Stück / pieces)
4-0	1.5	3 x 0,45	PT333*	24
3-0	2	3 x 0,45	PT433*	24
2-0	3	3 x 0,45	PT533	24

*eventuell mit verlängerter Lieferzeit verbunden / *possibly associated with an extended delivery time*



- mittelfristig resorbierbares Multifilament
- hohe Reißkraft
- minimales Gewebetrauma
- glatter Gewebedurchzug
- guter Knotensitz

- *midterm absorbable multifilament*
- *high tensile strength*
- *minimized tissue trauma*
- *smooth tissue passage*
- *perfect knot security*

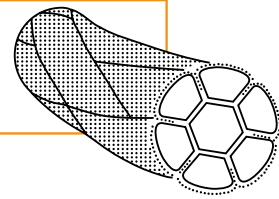

Eigenschaften:

- hohe Reißkraft
- gutes Handling
- guter Knotensitz
- atraumatischer Gewebedurchzug
- minimale Gewebereaktion

PGA RESORBA® ist ein Polymer der Glykolsäure. Die linear hochmolekulare Polyglykolsäure wird unter Einwirkung eines Katalysators über das Zwischenprodukt Glykolid, einem zyklischen Ester, synthetisiert.

Der Abbau des PGA-Fadenmaterials im Gewebe erfolgt durch Wasseraufnahme in Umkehrung der Synthese.

Die monomere Glykolsäure wird durch den normalen Stoffwechsel enzymatisch in CO_2 und H_2O gespalten. Fadenmaterial mit einem Anteil von 10% Lactid als Copolymer unterscheidet sich in seinem physikalischen und physiologischen Verhalten nur geringfügig von reinen PGA-Fäden.

Die feinen, präzisionsgeflochtenen Filamente gewähren eine sehr hohe Reißfestigkeit sowie eine ausgezeichnete Geschmeidigkeit.

Die spezielle Beschichtung legt sich fein um die Faserbündel und führt zu einer gezielten Herabsetzung der Oberflächenreibung. Resorbierbare Nahtmaterialien adaptieren das Gewebe während der Heilungsphase und verlieren dabei zunehmend ihre Zugfestigkeit und Reißkraft.

Bei PGA RESORBA® führen die präzisionsgeflochtenen Filamente aus Polyglykolsäure zu einem standardisierten, mittelfristigen Resorptionsverhalten im Gewebe. 18 Tage nach Implantation liegt die Reißkraft von PGA RESORBA® bei 50% der ursprünglichen Reißkraft.

Violettes PGA RESORBA® ist mit einem physiologisch unbedenklichen Farbstoff gefärbt.

- ➔ Farbe: violett oder ungefärbt
- ➔ Chemische Bezeichnung: Polyglykolsäure
- ➔ Fadenstärke: USP 8-0 -5 (0.4-7 metric)
- ➔ Konfektionsangebote:
 - Nadel-Faden-Kombinationen
 - in vorgeschrittenen Längen
- ➔ Sterilisation: Ethylenoxid

Properties:

- high tear resistance
- good handling
- excellent knot security
- atraumatic tissue passage
- minimal tissue reaction

PGA RESORBA® is a polymer of glycolic acid. The linear, high molecular weight polyglycolic acid is synthesised in the presence of a catalyst via the intermediary product glycolide, a cyclic ester.

The breakdown of the PGA suture in the tissue occurs through water

uptake, thereby reversing the synthesis. Regular metabolic processes break down the glycolic acid monomers into CO_2 and H_2O through enzymatic degradation. The physical and physiological properties of suture material containing 10% lactide as copolymer differ only slightly from pure PGA sutures.

The thin, precision-braided filaments provide very high tear resistance as well as excellent suppleness.

The special coating thinly encapsulates the fibre bundles resulting in a specific reduction of surface friction. Absorbable sutures approximate the tissue during the healing phase; at the same time, they increasingly lose their tensile strength and tear resistance.









PGA RESORBA® contains precision-braided filaments made of polyglycolic acid that result in a standardised, moderate rate of absorption in the tissue. Depending on the thread diameter 50 % of the original tensile strength of PGA RESORBA® is lost after 18 days.

Violet PGA RESORBA® is coloured with a physiologically harmless dye.

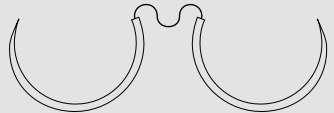
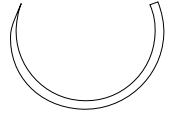
- ➔ Colour: violet or undyed
- ➔ Chemical name: polyglycolic acid
- ➔ Thread diameter: USP 8-0 -5 (0.4-7 metric)
- ➔ Types of packaging:
 - needle-thread-combinations
 - precut lengths
- ➔ Sterilization method: ethylene oxide

PGA RESORBA®







Sterile Nadel-Faden-Kombination / *needle suture combination, sterile*

Nadel / needle	Stärke / gauge		Länge / length (m)	Farbe / colour	Best.-Nr. / code no.	Packungsinhalt / box content (Stück / pieces)
	USP	metric				
FR = 5/8-Kreis Rundkörper <i>FR = 5/8 circle, taper point</i>						
FR 27 ● 	3-0	2	0,70	violett / violet	PA1011*	24
	2-0	3	0,70	violett / violet	PA1019	24
	0	3.5	0,70	violett / violet	PA1015	24
FR 35 ● 	0	3.5	0,70	violett / violet	PA1013	24
	1	4	0,70	violett / violet	PA1014	24
2 x FR 35 ● 	2-0	3	0,70	violett / violet	PA1012*	24
	0	3.5	0,90	violett / violet	PA1018*	24
FR 40 ● 	0	3.5	0,70	violett / violet	PA1016*	24
HR, HRS, HRX = 1/2-Kreis Rundkörper <i>HR, HRS, HRX = 1/2 circle, taper point</i>						
HR 8 ● 	7-0	0.5	0,45	violett / violet	PA10289*	12
HR 10 ● 	5-0	1	0,70	ungefärbt / undyed	PA10262*	24
HR 12 ● 	6-0	0.7	0,45	violett / violet	PA10273	24
	5-0	1	0,45	violett / violet	PA10274	24
	6-0	0.7	0,70	violett / violet	PA1021	24
	5-0	1	0,70	violett / violet	PA1022	24
	4-0	1.5	0,70	violett / violet	PA1023	24
	6-0	0.7	0,70	ungefärbt / undyed	PA10242	24
	5-0	1	0,70	ungefärbt / undyed	PA10265	24
	4-0	1.5	0,70	ungefärbt / undyed	PA10266	24
HRS 12 ● 	3-0	2	0,70	violett / violet	PA10328*	24
	2-0	3	0,70	violett / violet	PA10329*	24
	0	3.5	0,70	violett / violet	PA10330*	2
HR 17 ● 	5-0	1	0,70	violett / violet	PA1024	24
	4-0	1.5	0,70	violett / violet	PA1025	24
	3-0	2	0,70	violett / violet	PA1026	24
	2-0	3	0,70	violett / violet	PA1027	24
	5-0	1	0,70	ungefärbt / undyed	PA10248	24
	4-0	1.5	0,70	ungefärbt / undyed	PA10243	24
	3-0	2	0,70	ungefärbt / undyed	PA 0244	24
	2-0	3	0,70	ungefärbt / undyed	PA10258*	24

*eventuell mit verlängerter Lieferzeit verbunden / *possibly associated with an extended delivery time*

PGA RESORBA®

Sterile Nadel-Faden-Kombination / *needle suture combination, sterile*

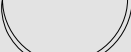





Nadel / needle	Stärke / gauge USP	metric	Länge / length (m)	Farbe / colour	Best.-Nr. / code no.	Packungsinhalt / box content (Stück / pieces)			
HRS 17 ●		2-0	3	0,70	violett / violet	PA10378*	24		
		0	3.5	0,70	violett / violet	PA10379*	24		
		1	4	0,70	violett / violet	PA10380*	24		
HR 17 A ● Abziehnadel / control release needle		5-0	1	4 x 0,45	violett / violet	PA10256* (M)	12		
		4-0	1.5	4 x 0,45	violett / violet	PA10287* (M)	12		
		3-0	2	4 x 0,45	violett / violet	PA10288* (M)	12		
		4-0	1.5	8 x 0,45	violett / violet	PA1028* (M)	12		
		3-0	2	8 x 0,45	violett / violet	PA1029* (M)	12		
		4-0	1.5	4 x 0,70	violett / violet	PA10284* (M)	12		
HR 22 ●		4-0	1.5	0,70	violett / violet	PA10210	24		
		3-0	2	0,70	violett / violet	PA10211	24		
		2-0	3	0,70	violett / violet	PA10212	24		
		3-0	2	4 x 0,70	violett / violet	PA10283* (M)	12		
		3-0	2	0,70	ungefärbt / undyed	PA10254	24		
		2-0	3	0,70	ungefärbt / undyed	PA10255*	24		
		4-0	1.5	4 x 0,45	violett / violet	PA10252 (M)	12		
HR 22 A ● Abziehnadel / control release needle		3-0	2	4 x 0,45	violett / violet	PA10286 (M)	12		
		2-0	3	4 x 0,45	violett / violet	PA10276 (M)	12		
		4-0	1.5	8 x 0,45	violett / violet	PA10213* (M)	12		
		3-0	2	8 x 0,45	violett / violet	PA10214 (M)	12		
		2-0	3	8 x 0,45	violett / violet	PA10215 (M)	12		
		3-0	2	4 x 0,70	violett / violet	PA10241* (M)	12		
		4-0	1.5	8 x 0,70	violett / violet	PA10285* (M)	12		
		HRS 22 ●		2-0	3	0,70	violett / violet	PA10331*	24
		0		3.5	0,70	violett / violet	PA10332	24	
1	4	0,70		violett / violet	PA10333	24			
HRS 22 A ● Abziehnadel / control release needle		0	3.5	4 x 0,70	violett / violet	PA10357* (M)	12		
HR 27 ●		4-0	1.5	0,70	violett / violet	PA10216	24		
		3-0	2	0,70	violett / violet	PA10217	24		
		2-0	3	0,70	violett / violet	PA10218	24		
		0	3.5	0,70	violett / violet	PA10219	24		
		4-0	1.5	0,90	violett / violet	PA10220*	24		
		3-0	2	0,90	violett / violet	PA10221	24		
		2-0	3	0,90	violett / violet	PA10222	24		
		0	3.5	0,90	violett / violet	PA10223	24		
		3-0	2	0,70	ungefärbt / undyed	PA10250	24		
		2-0	3	0,70	ungefärbt / undyed	PA10251	24		
		0	3.5	0,70	ungefärbt / undyed	PA10253*	24		
		2-0	3	6 x 0,70	violett / violet	PA10249* (M)	12		

*eventuell mit verlängerter Lieferzeit verbunden / possibly associated with an extended delivery time

(M) = Multipack

PGA RESORBA®

Sterile Nadel-Faden-Kombination / *needle suture combination, sterile*







Nadel / needle	Stärke / gauge		Länge / length (m)	Farbe / colour	Best.-Nr. / code no.	Packungsinhalt / box content (Stück / pieces)	
	USP	metric					
HR 27 A ● Abziehnadel / control release needle 	4-0	1.5	4 x 0,45	violett / violet	PA10227* (M)	12	
	3-0	2	4 x 0,45	violett / violet	PA10228 (M)	12	
	2-0	3	4 x 0,45	violett / violet	PA10229* (M)	12	
	4-0	1.5	8 x 0,45	violett / violet	PA10224* (M)	12	
	3-0	2	8 x 0,45	violett / violet	PA10225* (M)	12	
	2-0	3	8 x 0,45	violett / violet	PA10226* (M)	12	
	3-0	2	0,70	violett / violet	PA10280*	24	
	4-0	1.5	4 x 0,70	violett / violet	PA10230* (M)	12	
	3-0	2	4 x 0,70	violett / violet	PA10231 (M)	12	
	2-0	3	4 x 0,70	violett / violet	PA10232* (M)	12	
	0	3.5	4 x 0,70	violett / violet	PA10261* (M)	12	
	3-0	2	4 x 0,45	ungefärbt / undyed	PA10263* (M)	12	
	2-0	3	4 x 0,45	ungefärbt / undyed	PA10264* (M)	12	
	HRS 27 ● 	2-0	3	0,70	violett / violet	PA1030	24
0		3.5	0,70	violett / violet	PA1031	24	
1		4	0,70	violett / violet	PA1032	24	
2		5	0,70	violett / violet	PA10334	24	
2-0		3	0,90	violett / violet	PA10335*	24	
0		3.5	0,90	violett / violet	PA1033	24	
1		4	0,90	violett / violet	PA1034	24	
2		5	0,90	violett / violet	PA1035	24	
1		4	4 x 0,70	violett / violet	PA10364* (M)	12	
2		5	4 x 0,70	violett / violet	PA10351* (M)	12	
2-0		3	0,70	ungefärbt / undyed	PA10353*	24	
HRS 27 A ● Abziehnadel / control release needle 		2-0	3	4 x 0,45	violett / violet	PA10336* (M)	12
		0	3.5	4 x 0,45	violett / violet	PA10337 (M)	12
		1	4	4 x 0,45	violett / violet	PA10338* (M)	12
	0	3.5	8 x 0,45	violett / violet	PA10348* (M)	12	
	1	4	8 x 0,45	violett / violet	PA10372* (M)	12	
	0	3.5	4 x 0,70	violett / violet	PA10339* (M)	12	
	1	4	4 x 0,70	violett / violet	PA10340* (M)	12	
	2	5	4 x 0,70	violett / violet	PA10341* (M)	12	
	HRX 27 ● 	1	4	0,90	violett/violet	PA1041	24
HRX 27 A ● Abziehnadel / control release needle 	1	4	4 x 0,70	violett / violet	PA1045* (M)	12	
HR 30 ● 	3-0	2	0,70	violett / violet	PA10245	24	
	2-0	3	0,70	violett / violet	PA10233	24	
	0	3.5	0,70	violett / violet	PA10234	24	

*eventuell mit verlängerter Lieferzeit verbunden / possibly associated with an extended delivery time

(M) = Multipack

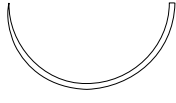
PGA RESORBA®

Sterile Nadel-Faden-Kombination / *needle suture combination, sterile*







Nadel / needle	Stärke / gauge		Länge / length (m)	Farbe / colour	Best.-Nr. / code no.	Packungsinhalt / box content (Stück / pieces)
	USP	metric				
HR 30 A ● Abziehnadel / <i>control release needle</i> 	0	3.5	4 x 0,70	violett / violet	PA10270* (M)	12
HRX 30 ● 	1	4	0,90	violett / violet	PA1042*	24
	2	5	0,90	violett / violet	PA1043*	24
HR 35 ● 	3-0	2	0,70	violett / violet	PA10246	24
	2-0	3	0,70	violett / violet	PA10235	24
	0	3.5	0,70	violett / violet	PA10236	24
	1	4	0,70	violett / violet	PA10237	24
	3-0	2	0,90	violett / violet	PA10247	24
	2-0	3	0,90	violett / violet	PA10238	24
	0	3.5	0,90	violett / violet	PA10239	24
	1	4	0,90	violett / violet	PA10240	24
	3-0	2	0,70	ungefärbt / undyed	PA10272*	24
HR 35 A ● Abziehnadel / <i>control release needle</i> 	3-0	2	4 x 0,45	violett/violet	PA10277* (M)	12
	2-0	3	8 x 0,70	violett/violet	PA10269* (M)	12
	0	3.5	4 x 0,70	violett/violet	PA10267* (M)	12
HRS 35 ● 	2-0	3	0,70	violett / violet	PA1037	24
	0	3.5	0,70	violett / violet	PA1038	24
	1	4	0,70	violett / violet	PA1039	24
	3-0	2	0,90	violett / violet	PA10371	24
	2-0	3	0,90	violett / violet	PA10310	24
	0	3.5	0,90	violett / violet	PA10311	24
	1	4	0,90	violett / violet	PA10312	24
	2	5	0,90	violett / violet	PA10313	24
	2-0	3	0,90	ungefärbt / undyed	PA10349	24
HRS 35 A ● Abziehnadel / <i>control release needle</i> 	0	3.5	4 x 0,45	violett / violet	PA10314* (M)	12
	1	4	4 x 0,45	violett / violet	PA10315 (M)	12
	2	5	4 x 0,45	violett / violet	PA10316* (M)	12
	0	3.5	8 x 0,50	violett / violet	PA10324* (M)	12
	1	4	4 x 0,70	violett / violet	PA10343 (M)	12
	2	5	4 x 0,70	violett / violet	PA10344* (M)	12
	1	4	4 x 0,90	violett / violet	PA10350* (M)	12
	0	3.5	4 x 0,45	ungefärbt / undyed	PA10360* (M)	12
	1	4	4 x 0,45	ungefärbt / undyed	PA10361* (M)	12
	HRX 35 ● 	0	3.5	0,70	violett / violet	PA1047*
1		4	0,70	violett / violet	PA1046*	24
1		4	0,90	violett / violet	PA1044*	24

*eventuell mit verlängerter Lieferzeit verbunden / *possibly associated with an extended delivery time*

(M) = Multipack

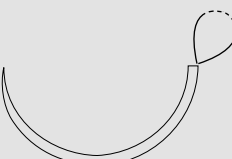
PGA RESORBA®

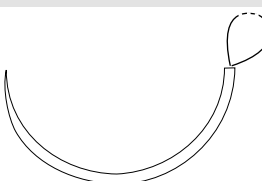
Sterile Nadel-Faden-Kombination / *needle suture combination, sterile*





Nadel / needle	Stärke / gauge USP	gauge metric	Länge / length (m)	Farbe / colour	Best.-Nr. / code no.	Packungsinhalt / box content (Stück / pieces)
HR 40 ● 	3-0	2	0,90	violett / violet	PA10290*	24
	2-0	3	0,90	violett / violet	PA10282	24
HRS 40 ● 	2-0	3	0,70	violett / violet	PA10370	24
	0	3.5	0,70	violett / violet	PA10317	24
	1	4	0,70	violett / violet	PA10318	24
	0	3.5	0,90	violett / violet	PA10319	24
	1	4	0,90	violett / violet	PA10320	24
	2	5	0,90	violett / violet	PA10321	24
	0	3.5	0,70	ungefärbt / undyed	PA10355*	24
	0	3.5	0,90	ungefärbt / undyed	PA10362*	24
	1	4	0,90	ungefärbt / undyed	PA10363*	24
	HRS 40 ● Schlinge / loop 	1	4	1,50	violett / violet	PAN10322 ¹⁾
HRS 40 A ●  Abziehnadel / control release needle	1	1	4 x 0,45	violett / violet	PA10323* (M)	12
	2	5	4 x 0,45	violett / violet	PA10345* (M)	12
	2-0	3	8 x 0,45	violett / violet	PA10365* (M)	12
	1	4	8 x 0,45	violett / violet	PA10373* (M)	12
	2	5	4 x 0,70	violett / violet	PA10375* (M)	12
HRS 48 ● 	3-0	2	0,70	violett / violet	PA10359*	24
	2-0	3	0,70	violett / violet	PA10368	24
	0	3.5	0,70	violett / violet	PA10377	24
	0	3.5	0,90	violett / violet	PA10325	24
	1	4	0,90	violett / violet	PA10326	24
	2	5	0,90	violett / violet	PA10327	24
	2	5	1,20	violett / violet	PA10354	24
	1	4	0,70	ungefärbt / undyed	PA10356*	24
	2	5	0,90	ungefärbt / undyed	PAN10374 ¹⁾	24
	HRS 48 ● Schlinge / loop 	1	4	1,50	violett / violet	PAN10352 ¹⁾
HRS 48 A ●  Abziehnadel / control release needle	1	4	4 x 0,45	violett / violet	PA10346* (M)	12
	2	5	4 x 0,45	violett / violet	PA10347* (M)	12
	2	5	8 x 0,45	violett / violet	PA10369 (M)	12

*eventuell mit verlängerter Lieferzeit verbunden / possibly associated with an extended delivery time

(M) = Multipack

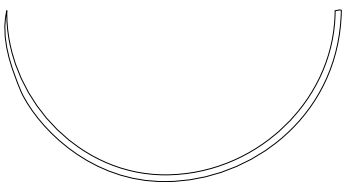
PGA RESORBA®

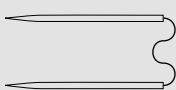
Sterile Nadel-Faden-Kombination / *needle suture combination, sterile*









Nadel / needle	Stärke / gauge		Länge / length (m)	Farbe / colour	Best.-Nr. / code no.	Packungsinhalt / box content (Stück / pieces)
	USP	metric				
HR 50 	2-0	3	0,70	violett / violet	PA10281*	24
	1	4	0,70	violett / violet	PA10278	24
	0	3.5	0,90	violett / violet	PA10279	24
	4	6	0,90	violett / violet	PA10271*	12
HR 70 	3-0	2	0,70	violett / violet	PA10275*	24
	2-0	3	0,70	violett / violet	PA10257	24
	0	3.5	0,70	violett / violet	PA10259	24
	1	4	0,70	violett / violet	PA10260	24
	1	4	1,20	violett / violet	PA10268*	24
HRX 75 	2	5	1,20	violett / violet	PA1048*	24
GR = Gerade Rundkörper <i>GR = straight, taper point</i>						
2 x GR 20 	4-0	1.5	0,35	violett / violet	PA1091*	24
HRT, HRTX = 1/2-Kreis schneidende Rundkörper (Diamond-Spitze) <i>HRT, HRTX = 1/2 circle, taper cutting</i>						
HRT 18 	4-0	1.5	0,70	violett / violet	PA1060	24
	3-0	2	0,70	violett / violet	PA1061	24
	2-0	3	0,70	violett / violet	PA10615	24
	0	3.5	0,70	violett / violet	PA10616*	24
	5-0	1	0,70	ungefärbt / undyed	PA10640*	24
	4-0	1.5	0,70	ungefärbt / undyed	PA10621	24
	3-0	2	0,70	ungefärbt / undyed	PA10613	24
	2-0	3	0,70	ungefärbt / undyed	PA1062*	24
HRT 18 A 	2-0	3	6 x 0,45	violett / violet	PA10620* (M)	12

*eventuell mit verlängerter Lieferzeit verbunden / *possibly associated with an extended delivery time*

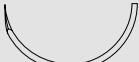
(M) = Multipack

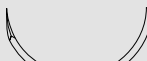
PGA RESORBA®

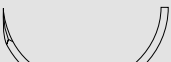
Sterile Nadel-Faden-Kombination / *needle suture combination, sterile*

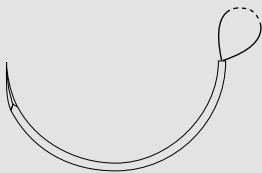





Nadel / needle	Stärke / gauge		Länge / length (m)	Farbe / colour	Best.-Nr. / code no.	Packungsinhalt / box content (Stück / pieces)
	USP	metric				
HRT 22 	3-0	2	0,70	violett / violet	PA10632	24
	2-0	3	0,70	violett / violet	PA10633	24
	3-0	2	0,70	ungefärbt / undyed	PA10625	24
	2-0	3	0,70	ungefärbt / undyed	PA10629*	24
HRT 22 A Abziehnadel / control release needle 	2-0	3	4 x 0,45	violett / violet	PA1068* (M)	12
HRT 25 	3-0	2	0,70	violett / violet	PA1064	24
	2-0	3	0,70	violett / violet	PA1065	24
	0	3.5	0,70	violett / violet	PA1066	24
	3-0	2	0,90	violett / violet	PA10641	24
	2-0	3	0,90	violett / violet	PA10642	24
	1	4	0,90	violett / violet	PA1067*	24
	2	5	0,90	violett / violet	PA1063*	24
	3-0	2	0,70	ungefärbt / undyed	PA10622	24
	2-0	3	0,70	ungefärbt / undyed	PA10628	24
HRT 25 A Abziehnadel / control release needle 	0	3.5	4 x 0,70	violett / violet	PA10614* (M)	12
	3-0	2	4 x 0,45	ungefärbt / undyed	PA10630* (M)	12
	2-0	3	4 x 0,45	ungefärbt / undyed	PA10631* (M)	12
HRT 30 	2-0	3	70	violett / violet	PA10635*	12
HRT 35 	1	4	0,70	violett / violet	PA10634*	24
	2-0	3	0,90	violett / violet	PA10610	24
	0	3.5	0,90	violett / violet	PA10611	24
	1	4	0,90	violett / violet	PA10612	24
	2	5	0,90	violett / violet	PA10624	24
	2-0	3	0,90	ungefärbt / undyed	PA10623	24
	2-0	3	1,00	ungefärbt / undyed	PA1069*	24
HRT 35 A Abziehnadel / control release needle 	1	4	4 x 0,45	violett / violet	PA10619* (M)	12
HRT 40 	1	4	0,70	violett / violet	PA10637*	24
	0	3.5	0,70	ungefärbt / undyed	PA10636*	24
	1	4	0,70	ungefärbt / undyed	PA10639*	24
HRT 45 Schlinge / loop 	1	4	1,50	violett / violet	PAN10627 ¹⁾	24

*eventuell mit verlängerter Lieferzeit verbunden / possibly associated with an extended delivery time

(M) = Multipack

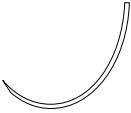
PGA RESORBA®

Sterile Nadel-Faden-Kombination / *needle suture combination, sterile*

Nadel / needle	Stärke / gauge		Länge / length (m)	Farbe / colour	Best.-Nr. / code no.	Packungsinhalt / box content (Stück / pieces)
	USP	metric				
HRTX 50 ▼ 	1	4	0,90	violett / violet	PA10617	24
ART = Asymptotische schneidende Rundkörper <i>ART = asymptotic, taper cutting</i>						
ART 16 ▼ 	4-0	1.5	0,45	ungefärbt / undyed	PA1282*	24
ART 25 ▼ 	4-0	1.5	0,45	violett / violet	PA1281	12
	4-0	1.5	0,70	violett / violet	PA1284	24
DR, DRF = 3/8-Kreis Rundkörper <i>DR, DRF = 3/8 circle, taper point</i>						
DR 10 F ● 	6-0	0.7	0,45	violett / violet	PA1071*	24
DR 12 A ● Abziehnadel / control release needle 	3-0	2	4 x 0,45	violett / violet	PA1072 (M)	12
DRT = 3/8-Kreis schneidende Rundkörper <i>DRT = 3/8 circle, taper cutting</i>						
DRT 12 ▼ 	6-0	0.7	0,45	violett / violet	PA1081	24
	5-0	1	0,45	violett / violet	PA1082	24
DRT 18 ▼ 	4-0	1.5	0,45	ungefärbt / undyed	PA1083	24
	3-0	2	0,70	ungefärbt / undyed	PA1084*	24

*eventuell mit verlängerter Lieferzeit verbunden / possibly associated with an extended delivery time

(M) = Multipack

PGA RESORBA®











Sterile Nadel-Faden-Kombination / *needle suture combination, sterile*

Nadel / needle	Stärke / gauge		Länge / length (m)	Farbe / colour	Best.-Nr. / code no.	Packungsinhalt / box content (Stück / pieces)
	USP	metric				
HS, HSX = 1/2-Kreis außen schneidend HSM = mit PREMIUM-Schliff <i>HS, HSX = 1/2 circle, reverse cutting</i> <i>HSM = PREMIUM cut</i>						
HSM 13 ▽ PREMIUM-Schliff / PREMIUM cut	5-0	1	0,45	ungefärbt/	PA1120	24
HS 18 ▼	4-0	1.5	0,70	violett / violet	PA11112	24
	3-0	2	0,70	violett / violet	PA11113	24
	2-0	3	0,70	violett / violet	PA11114*	24
HS 22 ▼	4-0	1.5	0,70	violett / violet	PA11119	24
	3-0	2	0,70	violett / violet	PA11117	24
	2-0	3	0,70	violett / violet	PA11118	24
	4-0	1.5	0,70	ungefärbt / undyed	PA11118	24
	3-0	2	0,70	ungefärbt / undyed	PA11119	24
	2-0	3	0,70	ungefärbt / undyed	PA11110*	24
	2-0	3	0,70	violett / violet	PA11117*	24
HSX 22 ▼	2-0	3	0,70	violett / violet	PA11117*	24
HS 27 ▼	0	3.5	0,70	violett / violet	PA11111*	24
HS 35 ▼	2-0	3	0,70	violett / violet	PA11110	24
	0	3.5	0,70	violett / violet	PA11111	24
	1	4	0,70	violett / violet	PA11112	24
HS 40 ▼	1	4	0,90	violett / violet	PAN11113 ¹⁾	24
	2	5	0,90	violett / violet	PAN11114 ¹⁾	24
HS 50 ▼	1	4	0,70	violett / violet	PA11116	24
	4	6	0,90	violett / violet	PA11115*	12

*eventuell mit verlängerter Lieferzeit verbunden / *possibly associated with an extended delivery time*

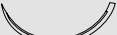
PGA RESORBA®

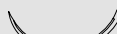







Sterile Nadel-Faden-Kombination / *needle suture combination, sterile*

Nadel / needle	Stärke / gauge		Länge / length (m)	Farbe / colour	Best.-Nr. / code no.	Packungsinhalt / box content (Stück / pieces)
	USP	metric				
DS = 3/8-Kreis außen schneidend DSM = mit PREMIUM-Schliff <i>DS = 3/8 circle, reverse cutting</i> <i>DSM = PREMIUM cut</i>						
DSM 11 ▽ PREMIUM-Schliff / PREMIUM cut 	6-0	0.7	0,45	ungefärbt / undyed	PA1158	24
2 x DSM 11 ▽ PREMIUM-Schliff / PREMIUM cut 	6-0	0.7	0,45	violett / violet	PA11520*	24
DS 13 ▼ 	4-0	1.5	0,70	ungefärbt / undyed	PAN11422 ¹⁾	24
DSM 13 ▽ PREMIUM-Schliff / PREMIUM cut 	5-0	1	0,45	violett / violet	PA1159	24
	6-0	0.7	0,70	violett / violet	PA11512	24
	5-0	1	0,70	violett / violet	PA11511	24
	6-0	0.7	0,45	ungefärbt / undyed	PA1150	24
	5-0	1	0,45	ungefärbt / undyed	PA1151	24
	4-0	1.5	0,45	ungefärbt / undyed	PA1152	24
2 x DSM 13 ▽ 	5-0	1	0,45	violett / violet	PA11515*	24
	4-0	1.5	0,45	violett / violet	PA11516*	24
PREMIUM-Schliff / PREMIUM cut						
2 x DSM 13 S ▽ 	5-0	1	0,45	violett / violet	PA11514*	24
	PREMIUM-Schliff / PREMIUM cut					
DS 18 F ▼ 	4-0	1.5	0,70	ungefärbt / undyed	PAN11414 ¹⁾	24
DS 18 ▼ 	5-0	1	0,45	violett / violet	PA11417	24
	4-0	1.5	0,45	violett / violet	PA11418	24
	4-0	1.5	0,70	violett / violet	PA11423	24
	3-0	2	0,70	violett / violet	PA11416	24
	5-0	1	0,45	ungefärbt / undyed	PA1140	24
	4-0	1.5	0,45	ungefärbt / undyed	PA1141	24
	3-0	2	0,45	ungefärbt / undyed	PA1142	24
	4-0	1.5	0,70	ungefärbt / undyed	PA11424*	24
	3-0	2	0,70	ungefärbt / undyed	PA11413	24
	3-0	2	0,45	ungefärbt / undyed	PA1142	24
DSM 18 ▽ PREMIUM-Schliff / PREMIUM cut 	5-0	1	0,70	violett / violet	PA11521	24
	4-0	1.5	0,70	violett / violet	PA11510	24
	4-0	1.5	0,45	ungefärbt / undyed	PA1154	24
	3-0	2	0,45	ungefärbt / undyed	PA1155	24
DSM 18 F ▽ PREMIUM-Schliff / PREMIUM cut 	4-0	1.5	0,45	ungefärbt / undyed	PA1153	24

*eventuell mit verlängerter Lieferzeit verbunden / possibly associated with an extended delivery time

PGA RESORBA®



















Sterile Nadel-Faden-Kombination / *needle suture combination, sterile*

Nadel / needle	Stärke / gauge USP	metric	Länge / length (m)	Farbe / colour	Best.-Nr. / code no.	Packungsinhalt / box content (Stück / pieces)
DS 24 	2-0	3	0,70	violett / violet	PA11412	24
	4-0	1.5	0,70	ungefärbt / undyed	PA1143*	24
	3-0	2	0,70	ungefärbt / undyed	PA1145	24
	2-0	3	0,70	ungefärbt / undyed	PA1146	24
DSM 24  PREMIUM-Schliff / PREMIUM cut	3-0	2	0,45	violett / violet	PA11513*	24
	3-0	2	0,45	ungefärbt / undyed	PA1156	24
	2-0	3	0,45	ungefärbt / undyed	PA1157	24
	4-0	1.5	0,70	ungefärbt / undyed	PA11517*	24
	3-0	2	0,70	ungefärbt / undyed	PA11519*	24
DS 30 	0	3.5	0,70	violett / violet	PA11411	24
	2-0	3	0,70	ungefärbt / undyed	PA1149	24
	3-0	2	0,70	ungefärbt / undyed	PA11421	24
	0	3.5	0,70	ungefärbt / undyed	PA1148	24
DS 40 	2-0	3	0,70	ungefärbt / undyed	PA11420	24
GS = Gerade schneidend <i>GS= straight, cutting</i>						
GS 12 	4-0	1.5	0,45	violett / violet	PA1175*	24
	4-0	1.5	0,70	ungefärbt / undyed	PA1171	24
GS 45 	4-0	1.5	0,45	ungefärbt / undyed	PA1174*	24
GS 60 	3-0	2	0,70	violett / violet	PA1177*	24
	2-0	3	0,70	violett / violet	PA1176*	24
	3-0	2	0,70	ungefärbt / undyed	PA1173*	24
	2-0	3	0,70	ungefärbt / undyed	PA1172	24
HSPM, HSPM F = 1/2-Kreis SPATULA, mit PREMIUM-Schliff <i>HSPM, HSPM F= 1/2 circle, spatulated, PREMIUM cut</i>						
2 x HSPM 7  PREMIUM-Schliff / PREMIUM cut	8-0	0.4	0,30	violett / violet	PAN1195 ¹⁾	12
	7-0	0.5	0,45	violett / violet	PA1194*	12
2 x HSPM 8  PREMIUM-Schliff / PREMIUM cut	5-0	1	0,45	violett / violet	PA1193	24
	6-0	0.7	0,45	ungefärbt / undyed	PA1192	24

*eventuell mit verlängerter Lieferzeit verbunden / *possibly associated with an extended delivery time*

PGA RESORBA®

Sterile Nadel-Faden-Kombination / *needle suture combination, sterile*

Nadel / needle	Stärke / gauge		Länge / length (m)	Farbe / colour	Best.-Nr. / code no.	Packungsinhalt / box content (Stück / pieces)
	USP	metric				
DSPM = 3/8-Kreis SPATULA, mit PREMIUM-Schliff						
<i>DSPM = 3/8 circle, spatulated, PREMIUM cut</i>						
DSPM 6 	8-0	0.4	0,30	violett / violet	PAN1204 ¹⁾	12
 PREMIUM-Schliff / <i>PREMIUM cut</i>	7-0	0.5	0,45	violett / violet	PAN1205 ¹⁾	24
2 x DSPM 6 	8-0	0.4	0,45	violett / violet	PAN1207 ¹⁾	12
 PREMIUM-Schliff / <i>PREMIUM cut</i>	7-0	0.5	0,45	violett / violet	PAN1208 ¹⁾	24
2 x DSPM 7 	7-0	0.5	0,45	violett / violet	PA1201	24
 PREMIUM-Schliff / <i>PREMIUM cut</i>						
2 x DSPM 8 	6-0	0.7	0,25	ungefärbt / undyed	PAN12014 ¹⁾	24
 PREMIUM-Schliff / <i>PREMIUM cut</i>						
DSPM 9 	6-0	0.7	0,45	violett / violet	PAN1202 ¹⁾	24
 PREMIUM-Schliff / <i>PREMIUM cut</i>						
2 x DSPM 11 	6-0	0.7	0,45	ungefärbt / undyed	PA1209*	24
 PREMIUM-Schliff / <i>PREMIUM cut</i>	4-0	1.5	0,45	ungefärbt / undyed	PA12011*	24
VSPM, VSPM F = 1/4-Kreis SPATULA, mit PREMIUM-Schliff						
<i>VSPM, VSPM F = 1/4 circle, spatulated, PREMIUM cut</i>						
VSPM 6 	6-0	0.7	0,45	violett / violet	PA1214	24
 PREMIUM-Schliff / <i>PREMIUM cut</i>						
2 x VSPM 8 	5-0	1	0,45	violett / violet	PAN12112 ¹⁾	24
 PREMIUM-Schliff / <i>PREMIUM cut</i>	6-0	0.7	0,45	violett / violet	PAN12113 ¹⁾	24
2 x VSPM 8 F 	6-0	0.7	0,45	violett / violet	PA1210	24
 PREMIUM-Schliff / <i>PREMIUM cut</i>	5-0	1	0,45	violett / violet	PAN1211 ¹⁾	24
	6-0	0.7	0,45	ungefärbt / undyed	PA1212	24
	5-0	1	0,45	ungefärbt / undyed	PA1213*	24

*eventuell mit verlängerter Lieferzeit verbunden / *possibly associated with an extended delivery time*

PGA RESORBA®

Einzelfadenpackungen, steril in vorgeschrittenen Längen / *Sterile pre-cut suture, non-needed*

Stärke / gauge USP	gauge metric	Länge / length (m)	Farbe / colour	Best.-Nr. / code no.	Packungsinhalt / box content (Stück / pieces)
6-0	0.7	3 x 0,45	violett / violet	PS133*	24
5-0	1	3 x 0,45	violett / violet	PS233*	24
4-0	1.5	3 x 0,45	violett / violet	PS333	24
3-0	2	3 x 0,45	violett / violet	PS433	24
2-0	3	3 x 0,45	violett / violet	PS533	24
0	3.5	3 x 0,45	violett / violet	PS633	24
1	4	3 x 0,45	violett / violet	PS733	24
2	5	3 x 0,45	violett / violet	PS833	24
5-0	1	6 x 0,45	violett / violet	PS265*	24
4-0	1.5	6 x 0,45	violett / violet	PS365	24
3-0	2	6 x 0,45	violett / violet	PS465	24
2-0	3	6 x 0,45	violett / violet	PS565	24
0	3.5	6 x 0,45	violett / violet	PS665	24
1	4	6 x 0,45	violett / violet	PS765	24
2	5	6 x 0,45	violett / violet	PS865	24
4-0	1.5	12 x 0,45	violett / violet	PS3125*	24
3-0	2	12 x 0,45	violett / violet	PS4125	24
2-0	3	12 x 0,45	violett / violet	PS5125	24
0	3.5	12 x 0,45	violett / violet	PS6125	24
1	4	12 x 0,45	violett / violet	PS7125	24
2	5	12 x 0,45	violett / violet	PS8125	24
5-0	1	2 x 0,70	violett / violet	PS220*	24
4-0	1.5	2 x 0,70	violett / violet	PS320*	24
3-0	2	2 x 0,70	violett / violet	PS420	24
2-0	3	2 x 0,70	violett / violet	PS520	24
0	3.5	2 x 0,70	violett / violet	PS620	24
1	4	2 x 0,70	violett / violet	PS720	24
2	5	2 x 0,70	violett / violet	PS820	24
4-0	1.5	5 x 0,70	violett / violet	PS350*	24
3-0	2	5 x 0,70	violett / violet	PS450	24
2-0	3	5 x 0,70	violett / violet	PS550	24
0	3.5	5 x 0,70	violett / violet	PS650	24
1	4	5 x 0,70	violett / violet	PS750	24
2	5	5 x 0,70	violett / violet	PS850	24
4	6 4	x 0,90	violett / violet	PS949*	24

*eventuell mit verlängerter Lieferzeit verbunden / *possibly associated with an extended delivery time*

PGA RESORBA®

Einzelfadenpackungen, steril in vorgeschrittenen Längen / *Sterile pre-cut suture, non-needed*

Stärke / gauge USP	metric	Länge / length (m)	Farbe / colour	Best.-Nr. / code no.	Packungsinhalt / box content (Stück / pieces)
2-0	3	1 x 1,50	violett / violet	PSN515 ¹⁾	24
0	3.5	1 x 1,50	violett / violet	PSN615 ¹⁾	24
1	4	1 x 1,50	violett / violet	PSN715 ¹⁾	24
2	5	1 x 1,50	violett / violet	PSN815 ¹⁾	24
5-0	1	3 x 0,45	ungefärbt / undyed	PU233*	24
4-0	1.5	3 x 0,45	ungefärbt / undyed	PU333	24
3-0	2	3 x 0,45	ungefärbt / undyed	PU433	24
2-0	3	3 x 0,45	ungefärbt / undyed	PU533	24
0	3.5	3 x 0,45	ungefärbt / undyed	PU633	24
1	4	3 x 0,45	ungefärbt / undyed	PU733*	24
4-0	1.5	6 x 0,45	ungefärbt / undyed	PU365*	24
3-0	2	6 x 0,45	ungefärbt / undyed	PU465	24
2-0	3	6 x 0,45	ungefärbt / undyed	PU565	24
0	3.5	6 x 0,45	ungefärbt / undyed	PU665	24
1	4	6 x 0,45	ungefärbt / undyed	PU765*	24
3-0	2	12 x 0,45	ungefärbt / undyed	PU4125*	24
2-0	3	12 x 0,45	ungefärbt / undyed	PU5125*	24
0	3.5	12 x 0,45	ungefärbt / undyed	PU6125*	24
1	4	12 x 0,45	ungefärbt / undyed	PU7125*	24
2-0	3	2 x 0,70	ungefärbt / undyed	PU520*	24
0	3.5	2 x 0,70	ungefärbt / undyed	PU620*	24
3-0	2	5 x 0,70	ungefärbt / undyed	PU450*	24
2-0	3	5 x 0,70	ungefärbt / undyed	PU550*	24
0	3.5	5 x 0,70	ungefärbt / undyed	PU650	24
1	4	5 x 0,70	ungefärbt / undyed	PU750*	24
4-0	1.5	1 x 2,50	violett / violet	PL100*	12
3-0	2	1 x 2,50	violett / violet	PL101	12
2-0	3	1 x 2,50	violett / violet	PL102	12
0	3.5	1 x 2,50	violett / violet	PL103	12
1	4	1 x 2,50	violett / violet	PL104	12
2	5	1 x 2,50	violett / violet	PL105	12
4	6	1 x 2,50	violett / violet	PL106*	12
5	7	1 x 2,50	violett / violet	PL107*	12

*eventuell mit verlängerter Lieferzeit verbunden / *possibly associated with an extended delivery time*

¹⁾ Produkt hergestellt durch / *product manufactured by:*



Healthium Medtech Private Limited (Formerly Sutures India Pvt. Ltd.)
No. 472/D, 13th Cross, 4th Phase · Peenya Industrial Area, Bangalore 560 058, India
Email: sales@suturesindia.com · Mfg. Lic. No.: KTK/28/283/96



- langfristig absorbierbar, synthetisch
- sehr hohe Reißkraft
- belastbarer und sicherer Knotensitz
- minimale Gewebereaktion

- *synthetic with a long period of action*
- *high tensile strength*
- *high knot security*
- *excellent biocompatibility*

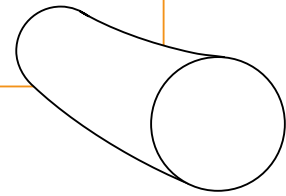

Eigenschaften:

- hohe Reißkraft
- minimale Gewebereaktion
- atraumatischer Gewebedurchzug
- guter Knotensitz

PDO RESORBA™ wird aus dem Polyester Poly (P-Dioxanon) hergestellt.

Durch das langfristige Resorptionsprofil ist PDO RESORBA™ ideal für alle Indikationen bei denen eine ausgedehnte Wundunterstützung benötigt wird. Nach Implantation liegt die Reißkraft nach 42 Tagen noch bei 55%. Die vollständige Resorption durch Hydrolyse ist nach etwa 25 - 31 Wochen abgeschlossen. Gewebereaktionen werden durch die monofile Struktur des Fadens minimiert.

PDO RESORBA™ ist ungefärbt oder violett eingefärbt erhältlich.

- ➔ Farbe: ungefärbt oder violett
- ➔ Chemische Bezeichnung: Poly (P-Dioxanon)
- ➔ Fadenstärke: USP 7-0 -2 (0.5-5 metric)
- ➔ Konfektionsangebote: Nadel-Faden-Kombinationen
- ➔ Sterilisation: Ethylenoxid

Properties:

- very high tensile strength
- minimal tissue reaction
- smooth passage through tissue
- robust and high knot security

PDO RESORBA™ is made of the polyester poly (p-dioxanone).

Because of its slow degradation profile, PDO RESORBA™ is well suited for all indications where an extended wound support is required. After implantation the breaking load is at 55% after 42 days. Absorption by hydrolysis is completed after about 25 - 31 weeks.









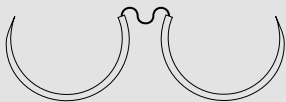

Tissue reaction is minimal because of the monofilament structure of the thread.

PDO RESORBA™ is supplied undyed or violet.

- ➔ Colour: violet or undyed
- ➔ Chemical name: poly (p-dioxanone)
- ➔ Thread diameter: USP 7-0 -2 (0.5-5 metric)
- ➔ Types of packaging: needle-thread-combinations
- ➔ Sterilization method: ethylene oxide



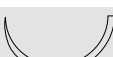

PDO RESORBA™

Sterile Nadel-Faden-Kombination / *needle suture combination, sterile*

Nadel / needle	Stärke / gauge		Länge / length (m)	Farbe / colour	Best.-Nr. / code no.	Packungsinhalt / box content (Stück / pieces)
	USP	metric				
FR = 5/8-Kreis Rundkörper <i>FR = 5/8 circle, taper point</i>						
2 x FR 27 ● 	3-0	2	0,70	violett / violet	PN2013	24
	2-0	3	0,70	violett / violet	PN2011	24
HR, HRS = 1/2-Kreis Rundkörper <i>HR, HRS = 1/2 circle, taper point</i>						
HR 12 ● 	7-0	0.5	0,70	violett / violet	PN20224	24
	6-0	0.7	0,70	violett / violet	PN2021	24
	5-0	1	0,70	violett / violet	PN2022	24
	4-0	1.5	0,70	violett / violet	PN2023	24
2 x HR 12 ● 	5-0	1	0,70	violett / violet	PN2024	24
HRS 12 ● 	3-0	2	0,70	violett / violet	PN2031	24
	2-0	3	0,70	violett / violet	PN2032	24
HR 17 ● 	6-0	0.7	0,70	violett / violet	PN2025	24
	5-0	1	0,70	violett / violet	PN2026	24
	4-0	1.5	0,70	violett / violet	PN2027	24
	3-0	2	0,70	violett / violet	PN2028	24
2 x HR 17 ● 	6-0	0.7	0,70	violett / violet	PN20223	24
	5-0	1	0,70	violett / violet	PN2029	24
	4-0	1.5	0,70	violett / violet	PN20210	24
HRS 17 ● 	3-0	2	0,70	violett / violet	PN20324	24
HR 22 ● 	4-0	1.5	0,70	violett / violet	PN20211	24
	3-0	2	0,70	violett / violet	PN20212	24
2x HR 22 ● 	6-0	0.7	0,70	violett / violet	PN20239	24
	5-0	1	0,70	violett / violet	PN20238	24
	4-0	1.5	0,70	violett / violet	PN20237	24
	3-0	2	0,70	violett / violet	PN20236	24
HRS 22 ● 	2-0	3	0,70	violett / violet	PN2034	24
	0	3.5	0,70	violett / violet	PN2035	24
HR 27 ● 	4-0	1.5	0,70	violett / violet	PN20213	24
	4-0	1.5	0,90	violett / violet	PN20242	24
	3-0	2	0,70	violett / violet	PN20214	24
	3-0	2	0,90	violett / violet	PN20234	24
	2-0	3	0,70	violett / violet	PN20215	24
	2-0	3	0,90	violett / violet	PN20241	24
	0	3.5	0,90	violett / violet	PN20230	24



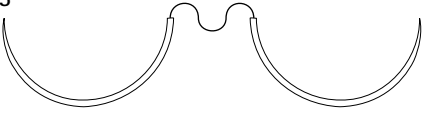

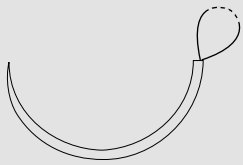
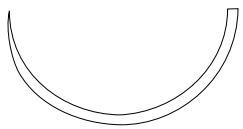
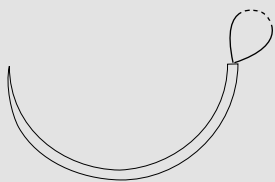





PDO RESORBA™

Sterile Nadel-Faden-Kombination / *needle suture combination, sterile*

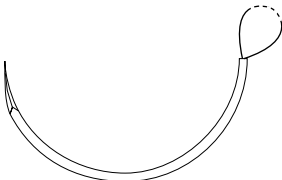
Nadel / needle	Stärke / gauge USP	gauge metric	Länge / length (m)	Farbe / colour	Best.-Nr. / code no.	Packungsinhalt / box content (Stück / pieces)
2 x HR 27 	4-0	1.5	0,70	violett / violet	PN20217	24
	4-0	1.5	0,90	violett / violet	PN20240	24
	3-0	2	0,70	violett / violet	PN20218	24
	3-0	2	0,90	violett / violet	PN20225	24
	2-0	3	0,70	violett / violet	PN20219	24
HRS 27 	2-0	3	0,70	violett / violet	PN2036	24
	0	3.5	0,70	violett / violet	PN2037	24
	1	4	0,70	violett / violet	PN2038	24
HR 35 	3-0	2	0,70	violett / violet	PN20220	24
	2-0	3	0,70	violett / violet	PN20221	24
2x HR 35 	4-0	1.5	0,70	violett / violet	PN20244	24
	3-0	2	0,70	violett / violet	PN20243	24
HRS 35 	2-0	3	0,70	violett / violet	PN2039	24
	0	3.5	0,70	violett / violet	PN20310	24
	1	4	0,70	violett / violet	PN20311	24
HRS 40 	2-0	3	0,90	violett / violet	PN20312	24
	0	3.5	0,90	violett / violet	PN20313	24
	1	4	0,90	violett / violet	PN20314	24
HRS 40 Schlinge / loop 	0	3.5	1,50	violett / violet	PN20318	24
	1	4	1,50	violett / violet	PN20319	24
HRS 48 	0	3.5	0,90	violett / violet	PN20315	24
	1	4	0,90	violett / violet	PN20316	24
	2	5	0,90	violett / violet	PN20317	24
HRS 48 Schlinge / loop 	1	4	1,80	violett / violet	PN20320	24



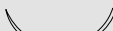





PDO RESORBA™

Sterile Nadel-Faden-Kombination / *needle suture combination, sterile*

Nadel / needle	Stärke / gauge USP	gauge metric	Länge / length (m)	Farbe / colour	Best.-Nr. / code no.	Packungsinhalt / box content (Stück / pieces)
HRT = 1/2-Kreis schneidende Rundkörper <i>HRT = 1/2 circle, taper cutting</i>						
HRT 18 ☉ 	5-0	1	0,70	violett / violet	PN2061	24
	4-0	1.5	0,70	violett / violet	PN2062	24
	3-0	2	0,70	violett / violet	PN2063	24
	2-0	3	0,70	violett / violet	PN2064	24
HRT 22 ☉ 	4-0	1.5	0,70	violett / violet	PN2065	24
	3-0	2	0,70	violett / violet	PN2066	24
HRT 25 ☉ 	4-0	1.5	0,70	violett / violet	PN2069	24
	3-0	2	0,70	violett / violet	PN2067	24
	2-0	3	0,70	violett / violet	PN2068	24
HRTX 35 ☉ 	0	3.5	0,90	violett / violet	PN20612	24
HRTX 45 ☉ 	1	4	0,90	violett / violet	PN20614	24
HRT 50 Schlinge / loop ☉ 	1	4	1,80	violett / violet	PN20610	24
DR = 3/8-Kreis Rundkörper <i>DR = 3/8 circle, taper point</i>						
2 x DR 10 ● 	7-0	0.5	0,70	violett / violet	PN2071	24
	6-0	0.7	0,70	violett / violet	PN2072	24
DR 12 ● 	6-0	0.7	0,70	violett / violet	PN2073	24
	5-0	1	0,70	violett / violet	PN2074	24
2 x DR 12 ● 	6-0	0.7	0,70	violett / violet	PN2075	24
	5-0	1	0,70	violett / violet	PN2076	24
2 x DR 12 F ● 	6-0	0.7	0,70	violett / violet	PN20710	24
DR 18 ● 	2-0	3	0,30	violett / violet	PN20713	24
DR 18 ● Schlinge / loop Tsuge-Naht / Tsuge suture 	4-0	1.5	0,30	violett / violet	PN2079	24
	3-0	2	0,30	violett / violet	PN2078	24
2x DR 18 ● 	6-0	0.7	0,70	violett / violet	PN20712	24
	5-0	1	0,70	violett / violet	PN20711	24

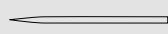
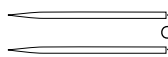
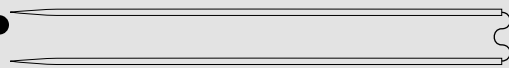







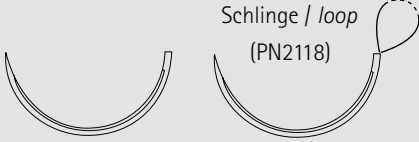

PDO RESORBA™

Sterile Nadel-Faden-Kombination / *needle suture combination, sterile*

Nadel / needle	Stärke / gauge		Länge / length (m)	Farbe / colour	Best.-Nr. / code no.	Packungsinhalt / box content (Stück / pieces)
	USP	metric				
DRT = 3/8-Kreis schneidende Rundkörper (Diamond-Spitze), DRTM = mit PREMIUM-Schliff <i>DRT = 3/8 circle, taper cutting</i> <i>DRTM = PREMIUM cut</i>						
DRTM 10 ⊖ PREMIUM-Schliff / PREMIUM cut 	7-0	0.5	0,70	violett / violet	PN2251	24
⊖ PREMIUM-Schliff / PREMIUM cut	6-0	0.7	0,70	violett / violet	PN2252	24
2 x DRTM 10 ⊖ PREMIUM-Schliff / PREMIUM cut 	6-0	0.7	0,70	violett / violet	PN2254	24
DRTM 12 ⊖ PREMIUM-Schliff / PREMIUM cut 	6-0	0.7	0,70	violett / violet	PN2255	24
⊖ PREMIUM-Schliff / PREMIUM cut	5-0	1	0,70	violett / violet	PN2256	24
2 x DRTM 12 ⊖ PREMIUM-Schliff / PREMIUM cut 	6-0	0.7	0,70	violett / violet	PN2257	24
⊖ PREMIUM-Schliff / PREMIUM cut	5-0	1	0,70	violett / violet	PN2258	24
DRT 18 ⊖ 	4-0	1.5	0,45	violett / violet	PN2081	24
GR = Gerade Rundkörper <i>GR = straight, taper point</i>						
GR 20 ● 	4-0	1.5	0,45	violett / violet	PN2096	24
2 x GR 20 ● 	4-0	1.5	0,35	violett / violet	PN2091	24
2 x GR 65 ● 	0	3.5	0,70	violett / violet	PN2092	24
	1	4	0,70	violett / violet	PN2093	24
2 x GRW 65 ● biegsame Nadel / flexible needle 	3-0	2	0,70	violett / violet	PN2095	24
ART = Asymptotische schneidende Rundkörper <i>ART = Asymptotic, taper cutting</i>						
ART 25 ⊖ 	5-0	1	0,70	violett / violet	PN2282	24
	4-0	1.5	0,70	violett / violet	PN2281	24
HS = 1/2-Kreis außen schneidend <i>HS = 1/2 circle, reverse cutting</i>						
HS 27 ▼ 	2-0	3	0,70	violett / violet	PN2111	24
	0	3.5	0,70	violett / violet	PN2112	24
	1	4	0,70	violett / violet	PN2113	24

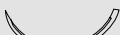
PDO RESORBA™

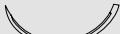
Sterile Nadel-Faden-Kombination / *needle suture combination, sterile*

Nadel / needle	Stärke / gauge		Länge / length (m)	Farbe / colour	Best.-Nr. / code no.	Packungsinhalt / box content (Stück / pieces)
	USP	metric				
HS 35 	2-0	3	1,50	violett / violet	PN2118	24
	0	3.5	0,70	violett / violet	PN2114	24
	1	4	0,70	violett / violet	PN2115	24
HS 40 	0	3.5	0,90	violett / violet	PN2116	24
DS = 3/8-Kreis außen schneidend, DSM = mit PREMIUM-Schliff <i>DS = 3/8 circle, reverse cutting, DSM = PREMIUM cut</i>						
DSM 11 	6-0	0.7	0,45	violett / violet	PN2151	24
	6-0	0.7	0,45	ungefärbt / undyed	PN2152	24
	5-0	1	0,45	ungefärbt / undyed	PN2153	24
DS 13 	5-0	1	0,45	ungefärbt / undyed	PN21412	24
DSM 13 	5-0	1	0,45	violett / violet	PN2154	24
	5-0	1	0,45	ungefärbt / undyed	PN2156	24
	4-0	1.5	0,45	violett / violet	PN2155	24
	4-0	1.5	0,45	ungefärbt / undyed	PN2157	24
DSM 16 	5-0	1	0,45	violett / violet	PN21518	24
DS 18 	5-0	1	0,45	ungefärbt / undyed	PN2146	24
	4-0	1.5	0,45	ungefärbt / undyed	PN2141	24
	4-0	1.5	0,70	ungefärbt / undyed	PN2147	24
	3-0	2	0,45	ungefärbt / undyed	PN2142	24
	3-0	2	0,70	ungefärbt / undyed	PN2148	24
	4-0	1.5	0,30	violett / violet	PN2149	24
DS 18 	Schlinge / loop					
Tsuge-Naht / Tsuge suture						
DSM 18 	4-0	1.5	0,45	violett / violet	PN21510	24
	4-0	1.5	0,45	ungefärbt / undyed	PN21512	24
	3-0	2	0,45	violett / violet	PN21511	24
	3-0	2	0,45	ungefärbt / undyed	PN21513	24
	3-0	2	0,45	ungefärbt / undyed	PN2143	24
DS 24 	4-0	1.5	0,45	ungefärbt / undyed	PN2143	24
	3-0	2	0,45	ungefärbt / undyed	PN2144	24
	3-0	2	0,70	ungefärbt / undyed	PN21411	24
	3-0	2	0,90	violett / violet	PN21410	24
	2-0	3	0,45	ungefärbt / undyed	PN2145	24
	4-0	1.5	0,45	ungefärbt / undyed	PN21514	24
DSM 24 	3-0	2	0,45	ungefärbt / undyed	PN21515	24
	2-0	3	0,45	ungefärbt / undyed	PN21516	24
	2-0	3	0,70	ungefärbt / undyed	PN21517	24



- nicht-resorbierbarer Polypropylenfaden
- dauerhaft hohe Reißfestigkeit
- hydrophob
- nicht-thrombogen
- geringste Gewebereaktion

- *non-absorbable suture*
- *high and permanent tensile strength*
- *water-repellent*
- *antithrombotic*
- *almost non-irritating*

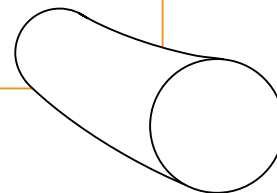

Eigenschaften:

- guter Knotensitz
- dauerhaft hohe Reißfestigkeit
- hervorragende Fadengleitfähigkeit
- hydrophob
- alterungsbeständig

MOPYLEN® ist ein synthetischer Faden, der durch Polymerisation von Propylen hergestellt wird.

Die Herstellung des Fadens erfolgt aus dem gefärbten Granulat nach dem Trockenspinverfahren.

Der Faden ist hydrophob, hat also praktisch keine Wasserabsorption und ist chemisch inert. MOPYLEN® ist ein idealer Hautfaden speziell für plastische Chirurgie und überall, wo es auf ein besonders gutes kosmetisches Ergebnis ankommt.

Das Material ist mit einem physiologisch unbedenklichen Farbstoff eingefärbt.

- Farbe: blau
- Chemische Bezeichnung: isotaktisches Polypropylen
- Fadenstärke: USP 10-0 –2 (0.2-5 metric)
- Konfektionsangebote:
 - Nadel-Faden-Kombinationen
- Sterilisation: Ethylenoxid

Properties:

- excellent knot security
- consistently high tear resistance
- excellent tissue passage
- hydrophobic
- non-ageing

MOPYLEN® is a synthetic suture, which is manufactured by polymerising propylene.

The suture is produced from the dyed granules using the dry spinning process.

The suture is hydrophobic, i.e., it absorbs practically no water and is chemically inert.















MOPYLEN® is an ideal skin suture, especially in plastic surgery and anywhere, where an excellent cosmetic result is critical.

The material is coloured with a physiologically harmless dye.

- Colour: blue
- Chemical name: isotactic polypropylene
- Thread diameter: USP 10-0 –2 (0.2-5 metric)
- Types of packaging:
 - needle-thread-combinations
- Sterilization method: ethylene oxide

MOPYLEN®

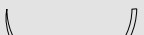
Sterile Nadel-Faden-Kombination / *needle suture combination, sterile*







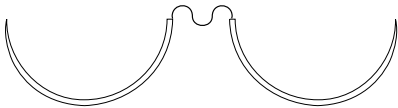

Nadel / needle	Stärke / gauge		Länge / length (m)	Farbe / colour	Best.-Nr. / code no.	Packungsinhalt / box content (Stück / pieces)
	USP	metric				
HR, HRS = 1/2-Kreis Rundkörper <i>HR, HRS = 1/2 circle, taper point</i>						
2 x HR 6 ● 	7-0	0.5	0,45	blau / blue	70235N ¹⁾	24
	6-0	0.7	0,45	blau / blue	70236N ¹⁾	24
HR 8 ● 	7-0	0.5	0,30	blau / blue	70223*	24
	7-0	0.5	0,30	blau / blue	70223N ¹⁾	24
	6-0	0.7	0,30	blau / blue	70224N ¹⁾	24
2 x HR 8 ● 	7-0	0.5	0,45	blau / blue	70225N ¹⁾	24
	6-0	0.7	0,45	blau / blue	70226N ¹⁾	24
HR 10 ● 	6-0	0.7	0,45	blau / blue	70230*	36
2 x HR 10 ● 	6-0	0.7	0,75	blau / blue	70231	36
HR 12 ● 	5-0	1	0,75	blau / blue	70232	36
2 x HR 12 ● 	6-0	0.7	0,75	blau / blue	7022	36
	5-0	1	0,75	blau / blue	7023	36
	4-0	1.5	0,90	blau / blue	7024	36
2 x HR 15 ● 	6-0	0.7	0,75	blau / blue	7025	36
	5-0	1	0,75	blau / blue	7026	36
	6-0	0.7	4 x 0,75	blau / blue	L70237* (M-L)	12
	5-0	1	4 x 0,75	blau / blue	L70238* (M-L)	12
HR 17 ● 	5-0	1	0,75	blau / blue	7027	36
	4-0	1.5	0,75	blau / blue	7028	36
	3-0	2	0,75	blau / blue	7029*	36
2 x HR 17 ● 	5-0	1	0,90	blau / blue	70210	36
	4-0	1.5	0,90	blau / blue	70211	36
	3-0	2	0,90	blau / blue	70212*	36
HR 22 ● 	4-0	1.5	0,75	blau / blue	70213	36
	3-0	2	0,75	blau / blue	70214	36
2 x HR 22 ● 	4-0	1.5	0,90	blau / blue	70215	36
	3-0	2	0,90	blau / blue	70216	36
HR 27 ● 	4-0	1.5	0,75	blau / blue	70238	36
	3-0	2	0,75	blau / blue	70217	36
	2-0	3	0,75	blau / blue	70218	36
	0	3.5	0,75	blau / blue	70219	36
2 x HR 27 ● 	5-0	1	0,75	blau / blue	70237*	36
	4-0	1.5	0,90	blau / blue	70220	36
	3-0	2	0,90	blau / blue	70221	36
	2-0	3	0,90	blau / blue	70222*	36
	4-0	1.5	1,20	blau / blue	70239*	36
	3-0	2	1,20	blau / blue	70240*	36

*eventuell mit verlängerter Lieferzeit verbunden / *possibly associated with an extended delivery time*

(M-L) = Multi-L-Pack

MOPYLEN®

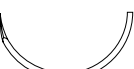

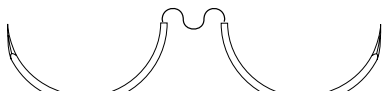





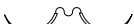

Sterile Nadel-Faden-Kombination / *needle suture combination, sterile*

Nadel / needle	Stärke / gauge		Länge / length	Farbe / colour	Best.-Nr. / code no.	Packungsinhalt / box content (Stück / pieces)
	USP	metric				
HRS 27 ● 	2-0	3	0,75	blau / blue	7031	36
	0	3.5	0,75	blau / blue	7032	36
2 x HR 35 ● 	3-0	2	0,90	blau / blue	70241*	36
HRS 35 ● 	2-0	3	0,75	blau / blue	7033	36
	0	3.5	0,75	blau / blue	7034	36
	1	4	0,75	blau / blue	7035	36
HRT = 1/2-Kreis schneidende Rundkörper <i>HRT = 1/2 circle, taper cutting</i>						
2 x HRT 13 ▼ 	5-0	1	0,60	blau / blue	70624*	36
	4-0	1.5	0,75	blau / blue	70625*	36
HRT 18 ▼ 	5-0	1	0,75	blau / blue	7061	36
	4-0	1.5	0,75	blau / blue	7062	36
	3-0	2	0,75	blau / blue	7063	36
2 x HRT 18 ▼ 	5-0	1	0,90	blau / blue	70612	36
	4-0	1.5	0,90	blau / blue	7064*	36
	3-0	2	0,90	blau / blue	7065*	36
	2-0	3	0,90	blau / blue	7066*	36
HRT 22 ▼ 	4-0	1.5	0,75	blau / blue	70613	36
	3-0	2	0,75	blau / blue	70614	36
	2-0	3	0,75	blau / blue	70615*	36
2 x HRT 22 ▼ 	4-0	1.5	0,90	blau / blue	70616*	36
HRT 25 ▼ 	3-0	2	0,75	blau / blue	7068	36
	2-0	3	0,75	blau / blue	7069	36
2 x HRT 25 ▼ 	3-0	2	0,90	blau / blue	70610*	36
	2-0	3	0,90	blau / blue	70611*	36
	3-0	2	1,20	blau / blue	70619*	36
2 x HRT 30 ▼ 	3-0	2	0,90	blau / blue	70623*	36
	2-0	3	0,90	blau / blue	70622*	36

*eventuell mit verlängerter Lieferzeit verbunden / *possibly associated with an extended delivery time*

MOPYLEN®

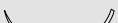
Sterile Nadel-Faden-Kombination / *needle suture combination, sterile*

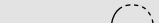
Nadel / needle	Stärke / gauge		Länge / length	Farbe / colour	Best.-Nr. / code no.	Packungsinhalt / box content (Stück / pieces)
	USP	metric				
DR, DR F = 3/8-Kreis Rundkörper <i>DR, DR F = 3/8 circle, taper point</i>						
DR 5 F ● 	10-0	0.2	0,15	blau / blue	70726N ¹⁾	24
DR 6 ● 	9-0	0.3	0,15	blau / blue	7072N ¹⁾	24
	8-0	0.4	0,15	blau / blue	70736N ¹⁾	24
2 x DR 6 ● 	8-0	0.4	0,45	blau / blue	7073N ¹⁾	24
	8-0	0.4	0,75	blau / blue	70732N ¹⁾	24
2 x DR 10 ● 	6-0	0.7	4 x 0,75	blau / blue	L70728* (M-L)	12
DR 10 F ● 	7-0	0.5	0,75	blau / blue	7074*	36
	6-0	0.7	0,75	blau / blue	70725*	36
2 x DR 10 F ● 	7-0	0.5	0,75	blau / blue	7076	36
	6-0	0.7	0,75	blau / blue	7077	36
	7-0	0.5	4 x 0,75	blau / blue	L70727* (M-L)	12
DR 12 ● 	5-0	1	0,75	blau / blue	7079*	36
	4-0	1.5	0,75	blau / blue	70710*	36
2 x DR 12 ● 	5-0	1	0,75	blau / blue	70712	36
	4-0	1.5	0,75	blau / blue	70713*	36
	5-0	1	0,90	blau / blue	70714*	36
	5-0	1	4 x 0,90	blau / blue	L70731* (M-L)	12
DR 12 F ● 	6-0	0.7	0,75	blau / blue	7078*	36
2 x DR 12 F ● 	7-0	0.5	0,60	blau / blue	70735*	36
	6-0	0.7	0,75	blau / blue	70711	36
	6-0	0.7	4 x 0,75	blau / blue	L70730* (M-L)	12
	5-0	1	0,75	blau / blue	70737*	36
DR 18 ● 	5-0	1	0,75	blau / blue	70715	36
	4-0	1.5	0,75	blau / blue	70716*	36
	3-0	2	0,75	blau / blue	70719*	36
2 x DR 18 ● 	5-0	1	0,90	blau / blue	70717	36
	4-0	1.5	0,90	blau / blue	70718*	36
	3-0	2	0,90	blau / blue	70720*	36
DR 18 ● Schlinge / loop Tsuge-Naht / Tsuge suture 	4-0	1.5	0,30	blau / blue	70734*	36
	3-0	2	0,30	blau / blue	70733*	36

*eventuell mit verlängerter Lieferzeit verbunden / *possibly associated with an extended delivery time*

(M-L) = Multi-L-Pack

MOPYLEN®









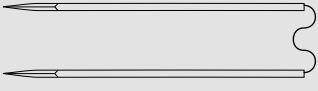

Sterile Nadel-Faden-Kombination / *needle suture combination, sterile*

Nadel / needle	Stärke / gauge USP	metric	Länge / length	Farbe / colour	Best.-Nr. / code no.	Packungsinhalt / box content (Stück / pieces)
DRT = 3/8-Kreis schneidende Rundkörper						
DRTM = mit PREMIUM-Schliff						
<i>DRT = 3/8 circle, taper cutting,</i>						
<i>DRTM = PREMIUM cut</i>						
DRTM 10	7-0	0.5	0,75	blau / blue	7251*	24
☉	6-0	0.7	0,75	blau / blue	7252*	24
PREMIUM-Schliff / <i>PREMIUM cut</i>						
2 x DRTM 10	5-0	1	0,60	blau / blue	72513*	24
☉	7-0	0.5	0,75	blau / blue	7253*	24
PREMIUM-Schliff / <i>PREMIUM cut</i>						
DRT 12	6-0	0.7	0,75	blau / blue	7081	36
☉	5-0	1	0,75	blau / blue	7082*	36
2 x DRT 12	6-0	0.7	0,75	blau / blue	7083*	36
☉	5-0	1	0,75	blau / blue	7084*	36
DRTM 12	6-0	0.7	0,75	blau / blue	7258*	24
☉						
PREMIUM-Schliff / <i>PREMIUM cut</i>						
2 x DRTM 12	6-0	0.7	0,45	blau / blue	72511*	24
☉	7-0	0.5	0,60	blau / blue	72514*	24
PREMIUM-Schliff / <i>PREMIUM cut</i>						
	6-0	0.7	0,75	blau / blue	72510*	24
	5-0	1	0,75	blau / blue	72512*	24
	5-0	1	0,90	blau / blue	7259*	24
DRT 18	5-0	1	0,75	blau / blue	7088*	36
☉	4-0	1.5	0,75	blau / blue	7089*	36
	3-0	2	0,75	blau / blue	70810*	36
GR = Gerade Rundkörper						
<i>GR = straight, taper point</i>						
2 x GR 20	4-0	1.5	0,35	blau / blue	7091*	36
●						
2 x GR 45	3-0	2	0,35	blau / blue	7092*	36
●						
2 x GR 65	2-0	3	0,75	blau / blue	7094	36
●						

*eventuell mit verlängerter Lieferzeit verbunden / *possibly associated with an extended delivery time*

MOPYLEN®









Sterile Nadel-Faden-Kombination / *needle suture combination, sterile*

Nadel / needle	Stärke / gauge		Länge / length	Farbe / colour	Best.-Nr. / code no.	Packungsinhalt / box content (Stück / pieces)
	USP	metric				
GRT = Gerade schneidende Rundkörper <i>GRT = straight, taper cutting</i>						
2 x GRT 40 ☉ 	4-0	1.5	0,35	blau / blue	7102*	36
HS = 1/2-Kreis außen schneidend HSM = mit PREMIUM-Schliff <i>HS = 1/2 circle, reverse cutting, HSM = PREMIUM cut</i>						
HSM 17 ▽ PREMIUM-Schliff / PREMIUM cut 	4-0	1.5	0,45	blau / blue	7126*	36
HS 18 ▼ 	3-0	2	0,45	blau / blue	7111*	36
HS 27 ▼ 	2-0	3	0,75	blau / blue	7112	36
	0	3.5	0,75	blau / blue	7113*	36
DS, DS F = 3/8-Kreis außen schneidend DSM, DSM F = mit PREMIUM-Schliff <i>DS, DS F = 3/8 circle, reverse cutting</i> <i>DSM, DSM F = PREMIUM cut</i>						
DSM 7 ▽ PREMIUM-Schliff / PREMIUM cut 	7-0	0.5	0,45	blau / blue	7151	36
	6-0	0.7	0,45	blau / blue	71525*	36
DSM 11 ▽ PREMIUM-Schliff / PREMIUM cut 	7-0	0.5	0,45	blau / blue	71526	36
	6-0	0.7	0,45	blau / blue	7152	36
	5-0	1	0,45	blau / blue	7153*	36
DSM 11 F ▽ PREMIUM-Schliff / PREMIUM cut 	6-0	0.7	0,45	blau / blue	71555	36
DS 13 ▼ 	5-0	1	0,45	blau / blue	7141	36
	4-0	1.5	0,45	blau / blue	7142	36
DSM 13 ▽ PREMIUM-Schliff / PREMIUM cut 	6-0	0.7	0,45	blau / blue	7155	36
	5-0	1	0,45	blau / blue	7156	36
	4-0	1.5	0,45	blau / blue	7157	36
	4-0	1.5	0,45	blau / blue	7157	36
DS 16 ▼ 	5-0	1	0,45	blau / blue	7145	36
	4-0	1.5	0,45	blau / blue	71446	36
DSM 16 ▽ PREMIUM-Schliff / PREMIUM cut 	6-0	0.7	0,45	blau / blue	71530	36
	5-0	1	0,45	blau / blue	71510	36
	4-0	1.5	0,45	blau / blue	71511	36

*eventuell mit verlängerter Lieferzeit verbunden / *possibly associated with an extended delivery time*

MOPYLEN®









Sterile Nadel-Faden-Kombination / *needle suture combination, sterile*

Nadel / needle		Stärke / gauge		Länge / length	Farbe / colour	Best.-Nr. / code no.	Packungsinhalt / box content (Stück / pieces)
		USP	metric				
DS 18 ▼		5-0	1	0,45	blau / blue	7147	36
		4-0	1.5	0,45	blau / blue	7148	36
		3-0	2	0,45	blau / blue	7149	36
		4-0	1.5	0,75	blau / blue	71410	36
		3-0	2	0,75	blau / blue	71411	36
DS 18 ▼ Schlinge / loop Tsuge-Naht / Tsuge Suture		4-0	1.5	0,30	blau / blue	71447*	36
		3-0	2	0,30	blau / blue	71448*	36
DS 18 F ▼		4-0	1.5	0,45	blau / blue	71436*	36
		4-0	1.5	0,75	blau / blue	71437*	36
DSM 18 F ▽ PREMIUM-Schliff / PREMIUM cut		4-0	1.5	0,45	blau / blue	71550	36
		4-0	1.5	0,75	blau / blue	71551*	36
DSM 18 ▽ PREMIUM-Schliff / PREMIUM cut		5-0	1	0,45	blau / blue	71512	36
		4-0	1.5	0,45	blau / blue	71513	36
		3-0	2	0,45	blau / blue	71514	36
		2-0	3	0,45	blau / blue	71515	36
		4-0	1.5	0,75	blau / blue	71516	36
		3-0	2	0,75	blau / blue	71517	36
		2-0	3	0,75	blau / blue	71518*	36
DS 21 ▼		4-0	1.5	0,45	blau / blue	71427	36
		3-0	2	0,45	blau / blue	71428	36
		2-0	3	0,45	blau / blue	71429*	36
		4-0	1.5	0,75	blau / blue	71430*	36
		3-0	2	0,75	blau / blue	71431*	36
		2-0	3	0,75	blau / blue	71432*	36
DSM 21 ▽ PREMIUM-Schliff / PREMIUM cut		4-0	1.5	0,45	blau / blue	71536*	36
		3-0	2	0,45	blau / blue	71537	36
		2-0	3	0,45	blau / blue	71538*	36
		4-0	1.5	0,75	blau / blue	71539*	36
		3-0	2	0,75	blau / blue	71540*	36
		2-0	3	0,75	blau / blue	71541	36
DS 24 ▼		4-0	1.5	0,45	blau / blue	71414*	36
		3-0	2	0,45	blau / blue	71415	36
		2-0	3	0,45	blau / blue	71425	36
		3-0	2	0,75	blau / blue	71416	36
		2-0	3	0,75	blau / blue	71426	36

*eventuell mit verlängerter Lieferzeit verbunden / possibly associated with an extended delivery time

MOPYLEN®



Sterile Nadel-Faden-Kombination / *needle suture combination, sterile*

Nadel / needle	Stärke / gauge USP	Stärke / gauge metric	Länge / length	Farbe / colour	Best.-Nr. / code no.	Packungsinhalt / box content (Stück / pieces)
DSM 24  PREMIUM-Schliff / <i>PREMIUM cut</i>	4-0	1.5	0,45	blau / blue	71520*	36
	3-0	2	0,45	blau / blue	71521	36
	2-0	3	0,45	blau / blue	71522	36
	4-0	1.5	0,75	blau / blue	71531	36
	3-0	2	0,75	blau / blue	71523	36
	2-0	3	0,75	blau / blue	71524	36
DS 27 	2-0	3	0,45	blau / blue	71418	36
	2-0	3	0,75	blau / blue	71433	36
DSM 27  PREMIUM-Schliff / <i>PREMIUM cut</i>	2-0	3	0,45	blau / blue	71542*	36
	2-0	3	0,75	blau / blue	71543*	36
DS 30 	2-0	3	0,45	blau / blue	71421*	36
	0	3.5	0,45	blau / blue	71422*	36
	4-0	1.5	0,75	blau / blue	71419*	36
	3-0	2	0,75	blau / blue	71420	36
	2-0	3	0,75	blau / blue	71424*	36
DSM 30  PREMIUM-Schliff / <i>PREMIUM cut</i>	0	3.5	0,45	blau / blue	71547*	36
	3-0	2	0,75	blau / blue	71544*	36
	2-0	3	0,75	blau / blue	71546*	36
DS 40 	2-0	3	0,75	blau / blue	71434*	36
	0	3.5	0,75	blau / blue	71423*	36
KS = 1/2-gebogen außen schneidend <i>KS = 1/2 curved, reverse cutting</i>						
KS 20 	3-0	2	0,45	blau / blue	7181*	36
GS = Gerade schneidend <i>GS = straight, cutting</i>						
GS 12 	4-0	1.5	0,45	blau / blue	7171*	36
GS 60 	3-0	2	0,75	blau / blue	7172*	36

*eventuell mit verlängerter Lieferzeit verbunden / *possibly associated with an extended delivery time*

MOPYLEN®

Sterile Nadel-Faden-Kombination / *needle suture combination, sterile*

Nadel / needle	Stärke / gauge USP	gauge metric	Länge / length	Farbe / colour	Best.-Nr. / code no.	Packungsinhalt / box content (Stück / pieces)
GSPM = Gerade SPATULA, PREMIUM-Schliff <i>GSPM = straight, spatulated, PREMIUM cut</i>						
2 x GSPM 16  PREMIUM-Schliff / <i>PREMIUM cut</i>	10-0	0.2	0,20	blau / <i>blue</i>	7261N ¹⁾	24
DSPM = 3/8-Kreis SPATULA, PREMIUM-Schliff <i>DSPM = 3/8 circle, spatulated, PREMIUM cut</i>						
2 x DSPM 7  PREMIUM-Schliff / <i>PREMIUM cut</i>	10-0	0.2	0,15	blau / <i>blue</i>	7208N ¹⁾	24

*eventuell mit verlängerter Lieferzeit verbunden / *possibly associated with an extended delivery time*

¹⁾ Produkt hergestellt durch / *product manufactured by:*



Healthium Medtech Private Limited (Formerly Sutures India Pvt. Ltd.)
No. 472/D, 13th Cross, 4th Phase · Peenya Industrial Area, Bangalore 560 058, India
Email: sales@suturesindia.com · Mfg. Lic. No.: KTK/28/283/96



- nicht-resorbierbarer PVDF-Faden
- chemisch inert
- hydrophob
- keinerlei Gewebereaktion

- *non-absorbable PVDF suture*
- *absolutely inert*
- *hydrophobic*
- *non-irritating*

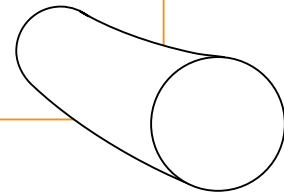

Eigenschaften:

- hydrophob, flexibel und elastisch
- sehr gute Fadengleitfähigkeit
- besonders hohe Geschmeidigkeit
- chemisch inert
- extrem alterungsbeständig

RESOPREN® ist ein monofiler, blauer Kunststofffaden aus Polyvinylidendifluorid (PVDF). Der Faden wird aus dem gefärbten Granulat im Trockenspinnverfahren hergestellt.

RESOPREN® ist chemisch inert, Wasser abstoßend, extrem alterungsbeständig.

Das Material ist mit einem physiologisch unbedenklichen Farbstoff eingefärbt.

- Farbe: blau
- Chemische Bezeichnung: Polyvinylidendifluorid
- Fadenstärke: USP 7-0 –2 (0.5-5 metric)
- Konfektionsangebote:
 - Nadel-Faden-Kombinationen
- Sterilisation: Ethylenoxid

Properties:

- hydrophobic, flexible and elastic
- excellent tissue passage
- extremely supple
- chemically inert
- extremely resistant to aging

RESOPREN® is a blue, monofilament, synthetic suture made of polyvinylidene difluoride (PVDF). The suture is produced from the dyed granules using the dry spinning process.









RESOPREN® is chemically inert, hydrophobic and highly resistant to ageing.

The material is coloured with a physiologically harmless dye.

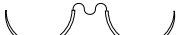
- Colour: blue
- Chemical name: polyvinylidene difluoride
- Thread diameter: USP 7-0 –2 (0.5-5 metric)
- Types of packaging:
 - needle-thread-combinations
- Sterilization method: ethylene oxide

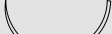
RESOPREN®

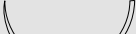
Sterile Nadel-Faden-Kombination / *needle suture combination, sterile*

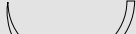



















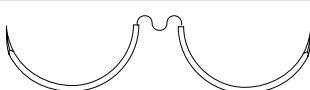





Nadel / needle	Stärke / gauge		Länge / length (m)	Farbe / colour	Best.-Nr. / code no.	Packungsinhalt / box content (Stück / pieces)
	USP	metric				
HR, HRS = 1/2-Kreis Rundkörper <i>HR, HRS = 1/2 circle, taper point</i>						
HR 10 ● 	6-0	0.7	0,45	blau / blue	77021	36
2 x HR 10 ● 	6-0	0.7	0,75	blau / blue	77022*	36
2 x HR 12 ● 	6-0	0.7	0,75	blau / blue	77023	36
	5-0	1	0,75	blau / blue	77024	36
	4-0	1.5	0,90	blau / blue	77025*	36
2 x HR 15 ● 	6-0	0.7	0,75	blau / blue	77026*	36
	5-0	1	0,75	blau / blue	77027	36
	6-0	0.7	4 x 0,75	blau / blue	L77028* (M-L)	12
	5-0	1	4 x 0,75	blau / blue	L77029* (M-L)	12
HR 17 ● 	5-0	1	0,75	blau / blue	770210	36
	4-0	1.5	0,75	blau / blue	770211	36
	3-0	2	0,75	blau / blue	770212	36
2 x HR 17 ● 	5-0	1	0,90	blau / blue	770213	36
	4-0	1.5	0,90	blau / blue	770214	36
	3-0	2	0,90	blau / blue	770215	36
HR 22 ● 	4-0	1.5	0,75	blau / blue	770216	36
	3-0	2	0,75	blau / blue	770217	36
2 x HR 22 ● 	4-0	1.5	0,90	blau / blue	770218	36
	3-0	2	0,90	blau / blue	770219*	36
HR 27 ● 	3-0	2	0,75	blau / blue	770220	36
	2-0	3	0,75	blau / blue	770221	36
2 x HR 27 ● 	4-0	1.5	0,90	blau / blue	770222*	36
	3-0	2	0,90	blau / blue	770223	36
	2-0	3	0,90	blau / blue	770224*	36
HRS 27 ● 	2-0	3	0,75	blau / blue	770227	36
	0	3.5	0,75	blau / blue	770228	36

*eventuell mit verlängerter Lieferzeit verbunden / *possibly associated with an extended delivery time*

(M-L) = Multi-L-Pack

RESOPREN®

Sterile Nadel-Faden-Kombination / *needle suture combination, sterile*













Nadel / needle	Stärke / gauge USP	metric	Länge / length (m)	Farbe / colour	Best.-Nr. / code no.	Packungsinhalt / box content (Stück / pieces)	
HRT = 1/2-Kreis schneidende Rundkörper <i>HRT = 1/2 circle, taper cutting</i>							
HRT 18 		5-0	1	0,75	blau / blue	77061	36
		4-0	1.5	0,75	blau / blue	77062	36
		3-0	2	0,75	blau / blue	77063*	36
2x HRT 18 		5-0	1	0,90	blau / blue	77064*	36
		4-0	1.5	0,90	blau / blue	77065	36
		3-0	2	0,90	blau / blue	77066*	36
		2-0	3	0,90	blau / blue	77067*	36
HRT 22 		4-0	1.5	0,75	blau / blue	77068*	36
		3-0	2	0,75	blau / blue	77069*	36
		2-0	3	0,75	blau / blue	770610	36
2 x HRT 22 		4-0	1.5	0,90	blau / blue	770611*	36
HRT 25 		3-0	2	0,75	blau / blue	770615*	36
		2-0	3	0,75	blau / blue	770616*	36
		0	3.5	0,75	blau / blue	770621*	36
2 x HRT 25 		3-0	2	0,90	blau / blue	770617*	36
		2-0	3	0,90	blau / blue	770618*	36
DR, DR F = 3/8-Kreis Rundkörper <i>DR, DR F = 3/8 circle, taper point</i>							
DR 10 		6-0	0.7	0,75	blau / blue	77074*	36
2 x DR 10 		6-0	0.7	0,75	blau / blue	77075*	36
		6-0	0.7	4 x 0,75	blau / blue	L77076* (M-L)	12
DR 10 F 		7-0	0.5	0,75	blau / blue	77071*	36
2 x DR 10 F 		7-0	0.5	0,75	blau / blue	77072	36
		7-0	0.5	4 x 0,75	blau / blue	L77073* (M-L)	12
DR 12 		5-0	1	0,75	blau / blue	770711*	36
		4-0	1.5	0,75	blau / blue	770712*	36
2 x DR 12 		5-0	1	0,75	blau / blue	770713*	36
		4-0	1.5	0,75	blau / blue	770714*	36
		5-0	1	0,90	blau / blue	770715*	36
		5-0	1	4 x 0,90	blau / blue	L770716* (M-L)	12
DR 12 F 		6-0	0.7	0,75	blau / blue	77078*	36
2 x DR 12 F 		6-0	0.7	0,75	blau / blue	77079	36
		6-0	0.7	4 x 0,75	blau / blue	L770710* (M-L)	12

*eventuell mit verlängerter Lieferzeit verbunden / *possibly associated with an extended delivery time*

(M-L) = Multi-L-Pack

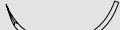
RESOPREN®

Sterile Nadel-Faden-Kombination / *needle suture combination, sterile*

Nadel / needle	Stärke / gauge		Länge / length (m)	Farbe / colour	Best.-Nr. / code no.	Packungsinhalt / box content (Stück / pieces)
	USP	metric				
DR 18 ● 	5-0	1	0,75	blau / blue	770718*	36
	4-0	1.5	0,75	blau / blue	770719*	36
	3-0	2	0,75	blau / blue	770720*	36
2 x DR 18 ● 	5-0	1	0,90	blau / blue	770721*	36
	4-0	1.5	0,90	blau / blue	770722*	36
	3-0	2	0,90	blau / blue	770723*	36
DRT = 3/8-Kreis schneidende Rundkörper DRTM = mit PREMIUM-Schliff <i>DRT = 3/8 circle, taper cutting,</i> <i>DRTM = PREMIUM cut</i>						
DRTM 10 ⊙ PREMIUM-Schliff / PREMIUM cut 	7-0	0.5	0,75	blau / blue	77251*	24
	6-0	0.7	0,75	blau / blue	77252*	24
2 x DRTM 10 ⊙ PREMIUM-Schliff / PREMIUM cut 	7-0	0.5	0,75	blau / blue	77253*	24
	6-0	0.7	0,75	blau / blue	77255*	24
DRT 12 ⊙ 	6-0	0.7	0,75	blau / blue	77081	36
	5-0	1	0,75	blau / blue	77082	36
2x DRT 12 ⊙ 	6-0	0.7	0,75	blau / blue	77083	36
	5-0	1	0,75	blau / blue	77084*	36
DRTM 12 ⊙ PREMIUM-Schliff / PREMIUM cut 	6-0	0.7	0,75	blau / blue	77257	24
	5-0	1	0,75	blau / blue	77258*	24
2 x DRTM 12 ⊙ PREMIUM-Schliff / PREMIUM cut 	6-0	0.7	0,75	blau / blue	772510*	24
	5-0	1	0,75	blau / blue	772511*	24
DRT 18 ⊙ 	5-0	1	0,75	blau / blue	77086*	36
	4-0	1.5	0,75	blau / blue	77087*	36
	3-0	2	0,75	blau / blue	77088*	36
DS = 3/8-Kreis außen schneidend DSM, DSM F = mit PREMIUM-Schliff <i>DS = 3/8 circle, reverse cutting</i> <i>DSM, DSM F = PREMIUM cut</i>						
DSM 7 ▽ PREMIUM-Schliff / PREMIUM cut 	7-0	0.5	0,45	blau / blue	771518*	36
	6-0	0.7	0,45	blau / blue	771519*	36
DSM 11 ▽ PREMIUM-Schliff / PREMIUM cut 	6-0	0.7	0,45	blau / blue	771520	36
DS 13 ▽ 	5-0	1	0,45	blau / blue	771411	36

*eventuell mit verlängerter Lieferzeit verbunden / *possibly associated with an extended delivery time*

RESOPREN®







Sterile Nadel-Faden-Kombination / *needle suture combination, sterile*

Nadel / needle	Stärke / gauge USP	metric	Länge / length (m)	Farbe / colour	Best.-Nr. / code no.	Packungsinhalt / box content (Stück / pieces)
DSM 13 ▽ PREMIUM-Schliff / <i>PREMIUM cut</i>	6-0	0,7	0,45	blau / blue	771526	36
	5-0	1	0,45	blau / blue	771517	36
	4-0	1,5	0,45	blau / blue	771527	36
DS 16 ▼	5-0	1	0,45	blau / blue	771415	36
	4-0	1,5	0,45	blau / blue	771412	36
DSM 16 ▽ PREMIUM-Schliff / <i>PREMIUM cut</i>	5-0	1	0,45	blau / blue	771525	36
	4-0	1,5	0,45	blau / blue	77151	36
DSM 16 F ▽ PREMIUM-Schliff / <i>PREMIUM cut</i>	5-0	1	0,45	blau / blue	771535	36
DS 18 ▼	5-0	1	0,45	blau / blue	771401	36
	4-0	1,5	0,45	blau / blue	771402	36
	3-0	2	0,45	blau / blue	771403	36
	4-0	1,5	0,75	blau / blue	771416	36
	3-0	2	0,75	blau / blue	771417	36
DS 18 ▼ Schlinge / <i>loop</i> Tsuge-Naht / <i>Tsuge Suture</i>	4-0	1,5	0,30	blau / blue	771431*	36
	3-0	2	0,30	blau / blue	771430*	36
DSM 18 ▽ PREMIUM-Schliff / <i>PREMIUM cut</i>	5-0	1	0,45	blau / blue	77152	36
	4-0	1,5	0,45	blau / blue	77153	36
	3-0	2	0,45	blau / blue	77154	36
	4-0	1,5	0,75	blau / blue	771529	36
	3-0	2	0,75	blau / blue	77155	36
	2-0	3	0,75	blau / blue	771530	36
	4-0	1,5	0,45	blau / blue	771521	36
DSM 18 F ▽ PREMIUM-Schliff / <i>PREMIUM cut</i>	4-0	1,5	0,45	blau / blue	771521	36
DS 21 ▼	3-0	2	0,45	blau / blue	771420	36
	2-0	3	0,45	blau / blue	771421	36
	3-0	2	0,75	blau / blue	771422	36
	2-0	3	0,75	blau / blue	771423	36
DSM 21 ▽ PREMIUM-Schliff / <i>PREMIUM cut</i>	3-0	2	0,45	blau / blue	771534	36
	4-0	1,5	0,75	blau / blue	771523	36
	3-0	2	0,75	blau / blue	771524*	36

*eventuell mit verlängerter Lieferzeit verbunden / *possibly associated with an extended delivery time*

RESOPREN®

Sterile Nadel-Faden-Kombination / *needle suture combination, sterile*

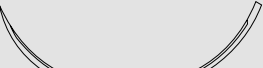
Nadel / needle	Stärke / gauge USP	metric	Länge / length (m)	Farbe / colour	Best.-Nr. / code no.	Packungsinhalt / box content (Stück / pieces)
DS 24 	4-0	1.5	0,45	blau / blue	71418	36
	3-0	2	0,45	blau / blue	771406	36
	2-0	3	0,45	blau / blue	771419	36
	3-0	2	0,75	blau / blue	771407	36
	2-0	3	0,75	blau / blue	771408	36
DSM 24  PREMIUM-Schliff / <i>PREMIUM cut</i>	4-0	1.5	0,45	blau / blue	771531*	36
	3-0	2	0,45	blau / blue	77158	36
	2-0	3	0,45	blau / blue	771532	36
	3-0	2	0,75	blau / blue	77159	36
	2-0	3	0,75	blau / blue	771510	36
DS 27 	2-0	3	0,45	blau / blue	771425*	36
	2-0	3	0,75	blau / blue	771426*	36
DS 30 	3-0	2	0,75	blau / blue	771424	36
	2-0	3	0,75	blau / blue	771413	36
	0	3.5	0,75	blau / blue	771414*	36
DSM 30  PREMIUM-Schliff / <i>PREMIUM cut</i>	3-0	2	0,75	blau / blue	771513*	36
	2-0	3	0,75	blau / blue	771514*	36
	0	3.5	0,75	blau / blue	771515*	36
DS 40 	2-0	3	0,75	blau / blue	771427*	36
	0	3.5	0,75	blau / blue	771428*	36
DSM 40  PREMIUM-Schliff / <i>PREMIUM cut</i>	0	3.5	0,75	blau / blue	771516*	36

*eventuell mit verlängerter Lieferzeit verbunden / *possibly associated with an extended delivery time*

POLYESTER



- nicht-resorbierbarer Polyesterfaden
- extrem zugfest
- hydrophob
- alterungsbeständig
- geringe Gewebereaktion

- *non-absorbable polyester suture*
- *high and permanent tensile strength*
- *hydrophobic*
- *non-ageing*
- *minimal tissue reactions*

POLYESTER

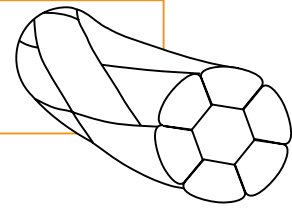

Eigenschaften:

- sehr hohe Reißfestigkeit
- hervorragende Fadengleitfähigkeit
- guter Knotensitz

POLYESTER wird durch Polykondensation von Ethylenglykol und Terephthalsäure hergestellt.

Die Faserbildung erfolgt nach dem Trockenspinnverfahren. Anschließend werden die gereckten, leicht verdrehten Faserbündel zu einem Faden präzisionsgeflochten und getempert. Der einzelne Faden ist hydrophob, nimmt also kein Wasser auf.

Das Material ist mit einem physiologisch unbedenklichen Farbstoff eingefärbt.

- Farbe: grün, weiß (ohne Farbstoff)
- Chemische Bezeichnung: Polyethylenterephthalat-Polyesterfaser
- Fadenstärke: USP 6-0 -8 (0.7-10 metric)
- Konfektionsangebote:
 - Nadel-Faden-Kombinationen
 - in vorgeschrittenen Längen
- Sterilisation: Ethylenoxid

Properties:

- very high tear resistance
- excellent tissue passage
- high knot security

POLYESTER is produced by polycondensation of ethylene glycol and terephthalic acid.

Fibres are formed using the dry spinning process. Precisionbraiding and tempering transform the stretched, slightly twisted fibre bundles into a suture. The individual fibres are hydrophobic, i.e., they repel water.

The material is coloured with a physiologically harmless dye.

- Colour: green, white (no dye)
- Chemical name: polyethylene terephthalate polyester fibre
- Thread diameter: USP 6-0 -8 (0.7-10 metric)
- Types of packaging:
 - needle-thread-combinations
 - pre-cut lengths
- Sterilization method: ethylene oxide

POLYESTER

Sterile Nadel-Faden-Kombination / *needle suture combination, sterile*

Nadel / needle	Stärke / gauge		Länge / length (m)	Farbe / colour	Best.-Nr. / code no.	Packungsinhalt / box content (Stück / pieces)
	USP	metric				
HR, HRS = 1/2-Kreis Rundkörper <i>HR, HRS = 1/2 circle, taper point</i>						
HR 10 ●	4-0	1.5	0,45	grün / green	8021*	36
HR 17 ●	5-0	1	0,75	grün / green	8022	36
	4-0	1.5	0,75	grün / green	8023	36
	3-0	2	0,75	grün / green	8024	36
	2-0	3	0,75	grün / green	8025*	36
2 x HR 17 ●	5-0	1	0,90	grün / green	8026*	36
	4-0	1.5	0,90	grün / green	80231*	36
HR 22 ●	4-0	1.5	0,75	grün / green	80210	36
	3-0	2	0,75	grün / green	80211	36
	2-0	3	0,75	grün / green	80212	36
HR 27 ●	3-0	2	0,75	grün / green	80215	36
	2-0	3	0,75	grün / green	80216	36
	0	3.5	0,75	grün / green	80217	36
	1	4	0,75	grün / green	80218	36
2 x HR 27 ●	3-0	2	0,90	grün / green	80221*	36
	2-0	3	0,90	grün / green	80222	36
HR 35 ●	2-0	3	0,75	grün / green	80224	36
	0	3.5	0,75	grün / green	80225	36
	1	4	0,75	grün / green	80226	36
HRS 35 ●	2-0	3	0,75	grün / green	8031*	36
	0	3.5	0,75	grün / green	8032*	36
HRT, HRTX = 1/2-Kreis schneidende Rundkörper <i>HRT, HRTX = 1/2 circle, taper cutting</i>						
HRT 18 ▼	4-0	1.5	0,45	grün / green	8069*	36
	3-0	2	0,45	grün / green	80616	36
	5-0	1	0,75	grün / green	8061	36
	4-0	1.5	0,75	grün / green	8062	36
	3-0	2	0,75	grün / green	8063	36
HRTX 50 ▼	6	8	6 x 0,75	grün / green	M80619* (M)	12

*eventuell mit verlängerter Lieferzeit verbunden / *possibly associated with an extended delivery time*

(M) = Multipack

POLYESTER

Sterile Nadel-Faden-Kombination / *needle suture combination, sterile*

Nadel / needle	Stärke / gauge USP	gauge metric	Länge / length (m)	Farbe / colour	Best.-Nr. / code no.	Packungsinhalt / box content (Stück / pieces)
ART = Asymptotische schneidende Rundkörper						
<i>ART = asymptotic, taper cutting</i>						
ART 13 ☉	4-0	1.5	0,45	grün / green	8281*	12
ART 25 ☉	4-0	1.5	0,45	grün / green	8282	12
	3-0	2	0,45	grün / green	8283*	12
HS = 1/2-Kreis außen schneidend						
<i>HS = 1/2 circle, reverse cutting</i>						
HS 18 ▼	5-0	1	0,45 g	grün / green	8111*	36
	4-0	1.5	0,45	grün / green	8119	36
	3-0	2	0,45	grün / green	8112	36
	3-0	2	0,75	grün / green	8117	36
	2-0	3	0,75	grün / green	8118	36
	3-0	2	0,45	grün / green	8113	36
HS 22 ▼	3-0	2	0,45	grün / green	8113	36
	3-0	2	0,75	grün / green	81110	36
HS 27 ▼	0	3.5	0,75	grün / green	8114	36
HS 35 ▼	1	4	0,75	grün / green	8115	36
HS 40 ▼	1	4	0,75	grün / green	8116	36

*eventuell mit verlängerter Lieferzeit verbunden / *possibly associated with an extended delivery time*

POLYESTER

Sterile Nadel-Faden-Kombination / *needle suture combination, sterile*







Nadel / needle	Stärke / gauge USP metric	Länge / length (m)	Farbe / colour	Best.-Nr. / code no.	Packungsinhalt / box content (Stück / pieces)	
DS, DS F = 3/8-Kreis außen schneidend DSM, DSM F = mit PREMIUM-Schliff <i>DS, DS F = 3/8 circle, reverse cutting</i> <i>DSM, DSM F = Premium cut</i>						
DSM 11 ▽ PREMIUM-Schliff / <i>PREMIUM cut</i>	6-0	0.7	0,45	grün / green	8151*	36
DS 13 ▼	5-0	1	0,45	grün / green	8141*	36
DSM 13 ▽ PREMIUM-Schliff / <i>PREMIUM cut</i>	5-0	1	0,45	grün / green	8156	36
	4-0	1.5	0,45	grün / green	8157*	36
DS 16 ▼	6-0	0.7	0,45	grün / green	8147*	36
	5-0	1	0,45	grün / green	8148	36
	4-0	1.5	0,45	grün / green	8149	36
DSM 16 ▽ PREMIUM-Schliff / <i>PREMIUM cut</i>	5-0	1	0,45	grün / green	81513*	36
	4-0	1.5	0,45	grün / green	81514*	36
DS 18 ▼	5-0	1	0,45	grün / green	81411*	36
	4-0	1.5	0,45	grün / green	81412	36
	3-0	2	0,45	grün / green	81413	36
	3-0	2	4 x 0,45	grün / green	M81416* (M)	24
DS 18 F ▼	4-0	1.5	0,45	grün / green	81430*	36
	4-0	1.5	0,45	weiß / white	81431*	36
DSM 18 ▽ PREMIUM-Schliff / <i>PREMIUM cut</i>	4-0	1.5	0,45	grün / green	81515	36
	3-0	2	0,45	grün / green	81516	36
	2-0	3	0,45	grün / green	81517*	36
DS 21 ▼	4-0	1.5	0,45	grün / green	81427*	36
	3-0	2	0,45	grün / green	81428	36
	2-0	3	0,45	grün / green	81429	36
DSM 21 ▽ PREMIUM-Schliff / <i>PREMIUM cut</i>	4-0	1.5	0,45	grün / green	81520*	36
	3-0	2	0,45	grün / green	81521*	36
	2-0	3	0,45	grün / green	81522*	36

*eventuell mit verlängerter Lieferzeit verbunden / *possibly associated with an extended delivery time*

(M) = Multipack

POLYESTER





Sterile Nadel-Faden-Kombination / *needle suture combination, sterile*

Nadel / needle	Stärke / gauge USP	metric	Länge / length (m)	Farbe / colour	Best.-Nr. / code no.	Packungsinhalt / box content (Stück / pieces)
DS 24 	3-0	2	0,45	grün / green	81418	36
	2-0	3	0,45	grün / green	81419	36
	3-0	2	0,75	grün / green	81437	36
	2-0	3	0,75	grün / green	81434	36
	3-0	2	0,45	weiß / white	81420*	36
DSM 24  PREMIUM-Schliff / <i>PREMIUM cut</i>	2-0	3	0,75	grün / green	81519	36
DS 27 	0	3.5	0,75	grün / green	81439*	36
	2-0	3	0,45	weiß / white	81421	36
DSM 27  PREMIUM-Schliff / <i>PREMIUM cut</i>	2-0	3	0,75	grün / green	81523*	36
DS 30 	0	3.5	0,45	grün / green	81435	36
	2-0	3	0,75	grün / green	81422	36
	0	3.5	0,75	grün / green	81423	36
	1	4	0,75	grün / green	81436	36
	3-0	2	0,45	weiß / white	81424*	36
	2-0	3	0,45	weiß / white	81425	36
DS 40 	1	4	0,75	grün / green	81438*	36
DS 80 	Ø 1,0 mm		1,50	weiß / white	81426*	12

*eventuell mit verlängerter Lieferzeit verbunden / *possibly associated with an extended delivery time*

POLYESTER

Sterile Nadel-Faden-Kombination / *needle suture combination, sterile*

Nadel / needle	Stärke / gauge		Länge / length (m)	Farbe / colour	Best.-Nr. / code no.	Packungsinhalt / box content (Stück / pieces)
	USP	metric				
GS = Gerade schneidend <i>GS = straight, cutting</i>						
GS 60 	2-0	3	0,75	grün / green	8173	36
HSPM = 1/2-Kreis SPATULA, PREMIUM-Schliff <i>HSPM = 1/2 circle, spatulated, Premium cut</i>						
2 x HSPM 8  PREMIUM-Schliff / <i>PREMIUM cut</i>	5-0	1	0,45	weiß / white	8191*	24
	4-0	1.5	0,45	weiß / white	8192*	24
VSPM, VSPM F = 1/4-Kreis SPATULA, PREMIUM-Schliff <i>VSPM, VSPM F = 1/4 circle, spatulated, PREMIUM cut</i>						
2 x VSPM 8  PREMIUM-Schliff / <i>PREMIUM cut</i>	4-0	1.5	0,45	weiß / white	8217*	24
2 x VSPM 8 F  PREMIUM-Schliff / <i>PREMIUM cut</i>	6-0	0.7	0,45	weiß / white	8211*	24
	5-0	1	0,45	weiß / white	8212*	24
	4-0	1.5	0,45	weiß / white	8213*	24

*eventuell mit verlängerter Lieferzeit verbunden / *possibly associated with an extended delivery time*

POLYESTER

Einzelfadenpackungen, steril in vorgeschnittenen Längen / *Sterile pre-cut suture, non-needed*

Stärke / gauge USP		Länge / length (m)	Farbe / colour	Best.-Nr. / code no.	Packungsinhalt / box content (Stück / pieces)
4-0	1.5	5 x 0,35	grün / green	R353*	24
3-0	2	5 x 0,35	grün / green	R453*	24
2-0	3	5 x 0,35	grün / green	R553*	24
0	3.5	5 x 0,35	grün / green	R653*	24
1	4	5 x 0,35	grün / green	R753*	24
3-0	2	5 x 0,35	weiß / white	WR453*	24
2-0	3	5 x 0,35	weiß / white	WR553*	24
5-0	1	3 x 0,50	grün / green	R235*	24
4-0	1.5	3 x 0,50	grün / green	R335	24
3-0	2	3 x 0,50	grün / green	R435	24
2-0	3	3 x 0,50	grün / green	R535	24
0	3.5	3 x 0,50	grün / green	R635	24
1	4	3 x 0,50	grün / green	R735	24
2	5	3 x 0,50	grün / green	R835*	24
3	6	3 x 0,50	grün / green	R935*	24
3-0	2	3 x 0,50	weiß / white	WR435*	24
2-0	3	3 x 0,50	weiß / white	WR535*	24
0	3.5	3 x 0,50	weiß / white	WR635*	24
2	5	3 x 0,50	weiß / white	WR835*	24
5-0	1	5 x 0,50	grün / green	R255*	24
4-0	1.5	5 x 0,50	grün / green	R355*	24
3-0	2	5 x 0,50	grün / green	R455	24
2-0	3	5 x 0,50	grün / green	R555	24
0	3.5	5 x 0,50	grün / green	R655	24
1	4	5 x 0,50	grün / green	R755*	24
2	5	5 x 0,50	grün / green	R855	24
3-0	2	5 x 0,50	weiß / white	WR455*	24
2-0	3	5 x 0,50	weiß / white	WR555*	24
0	3.5	5 x 0,50	weiß / white	WR655*	24

*eventuell mit verlängerter Lieferzeit verbunden / *possibly associated with an extended delivery time*

POLYESTER

Einzelfadenpackungen, steril in vorgeschrittenen Längen / *Sterile pre-cut suture, non-needed*

Stärke / gauge USP	metric	Länge / length (m)	Farbe / colour	Best.-Nr. / code no.	Packungsinhalt / box content (Stück / pieces)
4-0	1.5	6 x 0,50	grün / green	SR355	24
3-0	2	6 x 0,50	grün / green	SR455	24
2-0	3	6 x 0,50	grün / green	SR555	24
0	3.5	6 x 0,50	grün / green	SR655*	24
1	4	6 x 0,50	grün / green	SR755*	24
2	5	6 x 0,50	grün / green	SR 855*	24
3-0	2	10 x 0,50	grün / green	R4105	24
2-0	3	10 x 0,50	grün / green	R5105*	24
0	3.5	10 x 0,50	grün / green	R6105*	24
0	3.5	10 x 0,50	weiß / white	WR6105*	24
3-0	2	12 x 0,50	grün / green	SR4105*	24
2-0	3	12 x 0,50	grün / green	SR5105*	24
0	3.5	12 x 0,50	grün / green	SR6105*	24
1	4	12 x 0,50	grün / green	SR7105*	24
3-0	2	2 x 0,75	grün / green	R420*	24
2-0	3	2 x 0,75	grün / green	R520*	24
0	3.5	2 x 0,75	grün / green	R620*	24
1	4	2 x 0,75	grün / green	R720	24
2	5	2 x 0,75	grün / green	R820	24
3	6	2 x 0,75	grün / green	R920	24
3-0	2	2 x 0,75	weiß / white	WR420*	24
2-0	3	2 x 0,75	weiß / white	WR520*	24
0	3.5	2 x 0,75	weiß / white	WR620*	24
1	4	2 x 0,75	weiß / white	WR720*	24
3-0	2	5 x 0,75	grün / green	R450*	24
2-0	3	5 x 0,75	grün / green	R550	24
0	3.5	5 x 0,75	grün / green	R650*	24
1	4	5 x 0,75	grün / green	R750	24
2	5	5 x 0,75	grün / green	R850	24
0	3.5	1 x 1,20	grün / green	R612*	24
1	4	1 x 1,40	grün / green	SR712	24
2	5	1 x 1,40	grün / green	SR812*	24

*eventuell mit verlängerter Lieferzeit verbunden / *possibly associated with an extended delivery time*



- nicht-resorbierbarer Polyesterfaden
- extrem zugfest
- hydrophob
- alterungsbeständig
- sehr gewebefreundlich

- *non-absorbable suture*
- *high and permanent tensile strength*
- *hydrophobic*
- *non-ageing*
- *completely non-irritating*

SUPOLENE

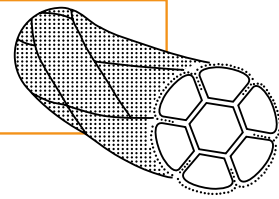

Eigenschaften:

- hohe Reißfestigkeit
- hervorragende Fadengleitfähigkeit, keine Sägewirkung
- sehr gleichmäßige und glatte Oberflächenbeschaffenheit
- sehr geringe Gewebereaktion
- geringe Kapillarität

SUPOLENE wird, ebenso wie POLYESTER, durch Polykondensation von Ethylenglykol und Terephthalsäure hergestellt.

Die Faserbildung erfolgt nach dem Trockenspinnverfahren. Anschließend wird der Faden präzisionsgeflochten, gefärbt, getempert und die Oberfläche durch Beschichtung des Fadens speziell veredelt. Durch diese Oberflächenbehandlung werden Kapillarität sowie Sägewirkung beim Gewebedurchzug und Knotenlauf auf ein Minimum reduziert.

SUPOLENE ist hydrophob, also ohne Wasserabsorptionseigenschaften. Das Material ist mit einem physiologisch unbedenklichen Farbstoff eingefärbt.

- ➔ Farbe: grün, weiß (ohne Farbstoff)
- ➔ Chemische Bezeichnung: Polyethylenterephthalat Polyesterfaser
- ➔ Fadenstärke: USP 6-0 -4 (0.7-6 metric)
- ➔ Konfektionsangebote:
 - Nadel-Faden-Kombinationen
 - in vorgeschrittenen Längen
- ➔ Sterilisation: Ethylenoxid

Properties:

- high tear resistance
- excellent tissue passage, no sawing effect
- very even and smooth surface properties
- very minimal tissue reaction
- minimal capillarity

Like POLYESTER, the production of SUPOLENE involves the polycondensation of ethylene glycol and terephthalic acid.

Fibres are formed using the dry spinning process. The suture then undergoes precision-braiding, dyeing and tempering and the surface is specially refined by coating. This surface treatment minimises capillarity and any sawing effect during tissue passage and knot rundown.

SUPOLENE is hydrophobic, i.e., it does not absorb water. The material is coloured with a physiologically harmless dye.

- ➔ Colour: green, white (no dye)
- ➔ Chemical name: polyethylene terephthalate polyester fibre
- ➔ Thread diameter: USP 6-0 -4 (0.7-6 metric)
- ➔ Types of packaging:
 - needle-thread-combinations
 - in precut lengths
- ➔ Sterilization method: ethylene oxide

SUPOLENE

Sterile Nadel-Faden-Kombination / *needle suture combination, sterile*









Nadel / needle	Stärke / gauge		Länge / length (m)	Farbe / colour	Best.-Nr. / code no.	Packungsinhalt / box content (Stück / pieces)
	USP	metric				
HR, HRX = 1/2-Kreis Rundkörper <i>HR, HRX = 1/2 circle, taper point</i>						
HR 12 ●	5-0	1	0,75	grün / green	9021*	36
		1.5	0,75	grün / green	9022*	36
HR 12 A ● Abziehnadel / control release needle	4-0	1.5	8 x 0,45	grün / green	A90232* (M)	12
2 x HR 15 ●	5-0	1	0,75	grün / green	9024*	36
HR 17 ●	5-0	1	0,75	grün / green	9025*	36
		1.5	0,75	grün / green	9026	36
		2	0,75	grün / green	9027	36
		3	0,75	grün / green	9028*	36
HR 17 A ● Abziehnadel / control release needle	4-0	1.5	8 x 0,45	grün / green	A90238* (M)	12
2 x HR 17 ●	4-0	1.5	0,90	grün / green	90210*	36
		2	0,90	grün / green	90214	36
		3	0,90	grün / green	90234*	36
HR 22 ●	4-0	1.5	0,75	grün / green	90215*	36
		2	0,75	grün / green	90216	36
		3	0,75	grün / green	90217	36
HR 22 A ● Abziehnadel / control release needle	4-0	1.5	4 x 0,45	grün / green	A90233 (M)	12
2 x HRX 22 ●	2	5	0,75	grün / green	9043*	24
HR 27 ●	4-0	1.5	0,75	grün / green	90233*	36
		2	0,75	grün / green	90218	36
		3	0,75	grün / green	90219	36
		3.5	0,75	grün / green	90220	36
		4	0,75	grün / green	90221	36
		3	1,20	grün / green	90222	36
		3.5	1,20	grün / green	90223*	36
		3	6 x 0,75	grün / green	M90222* (M)	12
		3	0,75	grün / green	9042	24
2 x HRX 27 ●	2	5	0,75	grün / green	9041	24
		6	0,75	grün / green	9042	24
HR 30 ●	2-0	3	0,75	grün / green	90227	36
		3.5	0,75	grün / green	90228	36
HR 35 ●	0	3.5	0,75	grün / green	90230	36
		4	0,75	grün / green	90231	36

*eventuell mit verlängerter Lieferzeit verbunden / possibly associated with an extended delivery time

(M) = Multipack

SUPOLENE

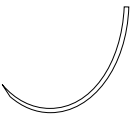
Sterile Nadel-Faden-Kombination / *needle suture combination, sterile*







Nadel / needle	Stärke / gauge USP	gauge metric	Länge / length (m)	Farbe / colour	Best.-Nr. / code no.	Packungsinhalt / box content (Stück / pieces)
HRT = 1/2-Kreis schneidende Rundkörper <i>HRT = 1/2 circle, taper cutting</i>						
HRT 18 ☉ 	5-0	1	0,45	grün / green	90630	36
	4-0	1.5	0,45	grün / green	90612	36
	5-0	1	0,75	grün / green	9061	36
	4-0	1.5	0,75	grün / green	9062	36
	3-0	2	0,75	grün / green	9063	36
	2-0	3	0,75	grün / green	9064	36
	0	3.5	0,75	grün / green	90652*	36
2 x HRT 18 ☉ 	4-0	1.5	0,75	grün / green	9067*	36
	3-0	2	0,75	grün / green	9068*	36
	2-0	3	0,75	grün / green	9069*	36
	0	3.5	0,75	grün / green	90610	36
HRT 25 ☉ 	3-0	2	0,75	grün / green	90616	36
	2-0	3	0,75	grün / green	90617*	36
	0	3.5	0,75	grün / green	90618	36
HRT 35 ☉ 	2	5	0,75	grün / green	90655	24
HRT 45 ☉ 	0	3.5	0,75	grün / green	90620*	24
	2	5	0,75	grün / green	90626	24
	2	5	4 x 0,75	grün / green	M90613* (M)	12
ART = Asymptotische schneidende Rundkörper <i>ART = asymptotic, taper cutting</i>						
ART 13 ☉ 	5-0	1	0,45	grün / green	9284*	12
	4-0	1.5	0,45	grün / green	9281*	12
ART 25 ☉ 	4-0	1.5	0,45	grün / green	9282	12
	3-0	2	0,45	grün / green	9283	12
DR = 3/8-Kreis Rundkörper <i>DR = 3/8 circle, taper point</i>						
DR 20 ● 	3-0	2	0,75	grün / green	90718	36

*eventuell mit verlängerter Lieferzeit verbunden / *possibly associated with an extended delivery time*

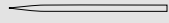
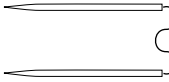
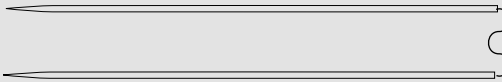
(M) = Multipack

SUPOLENE

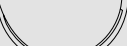
Sterile Nadel-Faden-Kombination / *needle suture combination, sterile*

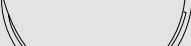
Nadel / needle	Stärke / gauge		Länge / length (m)	Farbe / colour	Best.-Nr. / code no.	Packungsinhalt / box content (Stück / pieces)
	USP	metric				
GR = Gerade Rundkörper <i>GR = straight, taper point</i>						
GR 20 ● 	4-0	1.5	0,45	grün / green	9096	36
	3-0	2	0,45	grün / green	9091	36
2 x GR 20 ● 	4-0	1.5	0,35	grün / green	9093*	36
2 x GR 65 ● 	3	6	0,75	grün / green	9094*	24
DRT = 3/8-Kreis schneidende Rundkörper (Diamond-Spitze) <i>DRT = 3/8 circle, taper cutting</i>						
DRT 12 ⊙ 	6-0	0.7	0,75	grün / green	9081*	36
	5-0	1	0,75	grün / green	9082*	36
DRT 18 ⊙ 	3-0	2	0,75	grün / green	9087	36
	2-0	3	0,75	grün / green	9088*	36
HS = 1/2-Kreis außen schneidend <i>HS = 1/2 circle, reverse cutting</i>						
HS 18 ▼ 	4-0	1.5	0,45	grün / green	9118*	36
	3-0	2	0,45	grün / green	9111*	36
HS 22 ▼ 	3-0	2	0,75	grün / green	9112	36
	2-0	3	0,75	grün / green	9113	36
HS 27 ▼ 	0	3.5	0,75	grün / green	9115	36
HS 35 ▼ 	1	4	0,75	grün / green	9116	36
HS 40 ▼ 	1	4	0,75	grün / green	9117*	36

*eventuell mit verlängerter Lieferzeit verbunden / *possibly associated with an extended delivery time*

SUPOLENE

Sterile Nadel-Faden-Kombination / *needle suture combination, sterile*









Nadel / needle	Stärke / gauge USP	metric	Länge / length (m)	Farbe / colour	Best.-Nr. / code no.	Packungsinhalt / box content (Stück / pieces)
DS = 3/8-Kreis außen schneidend, DSM = mit PREMIUM-Schliff <i>DS = 3/8 circle, reverse cutting, DSM = PREMIUM cut</i>						
DSM 11 ▽ PREMIUM-Schliff / <i>PREMIUM cut</i>	6-0	0.7	0,45	grün / green	9151	36
DS 13 ▼	4-0	1.5	0,45	grün / green	9142*	36
DSM 13 ▽ PREMIUM-Schliff / <i>PREMIUM cut</i>	5-0	1	0,45	grün / green	9152	36
	4-0	1.5	0,45	grün / green	9153	36
DSM 16 ▽ PREMIUM-Schliff / <i>PREMIUM cut</i>	5-0	1	0,45	grün / green	9155	36
	4-0	1.5	0,45	grün / green	9156	36
DS 18 ▼	5-0	1	0,45	grün / green	9144	36
	4-0	1.5	0,45	grün / green	9145	36
	3-0	2	0,45	grün / green	9146	36
DS 18 F ▼	4-0	1.5	0,45	grün / green	91427*	36
DSM 18 ▽ PREMIUM-Schliff / <i>PREMIUM cut</i>	4-0	1.5	0,45	grün / green	9157	36
	3-0	2	0,45	grün / green	9158	36
	2-0	3	0,45	grün / green	9159	36
	4-0	1.5	0,75	grün / green	91526	36
	3-0	2	4 x 0,45	grün / green	M91515* (M)	24
DS 21 ▼	4-0	1.5	0,45	grün / green	91423*	36
	3-0	2	0,45	grün / green	91424	36
	2-0	3	0,45	grün / green	91425*	36
DSM 21 ▽ PREMIUM-Schliff / <i>PREMIUM cut</i>	4-0	1.5	0,45	grün / green	91516*	36
	3-0	2	0,45	grün / green	91517*	36
	2-0	3	0,45	grün / green	91518*	36
DS 24 ▼	4-0	1.5	0,45	grün / green	9147*	36
	3-0	2	0,45	grün / green	9148	36
	2-0	3	0,45	grün / green	9149	36
	3-0	2	0,75	grün / green	91410*	36
	0	3.5	0,75	grün / green	91433	36
DSM 24 ▽ PREMIUM-Schliff / <i>PREMIUM cut</i>	3-0	2	0,75	grün / green	91513*	36
	2-0	3	0,75	grün / green	91514	36
DS 27 ▼	2-0	3	0,45	grün / green	91411	36
	2-0	3	0,75	grün / green	91426	36
DSM 27 ▽ PREMIUM-Schliff / <i>PREMIUM cut</i>	2-0	3	0,45	grün / green	91520*	36
	2-0	3	0,75	grün / green	91519*	36

*eventuell mit verlängerter Lieferzeit verbunden / *possibly associated with an extended delivery time*

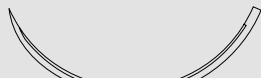
(M) = Multipack

SUPOLENE

Sterile Nadel-Faden-Kombination / *needle suture combination, sterile*

Nadel / needle	Stärke / gauge		Länge / length (m)	Farbe / colour	Best.-Nr. / code no.	Packungsinhalt / box content (Stück / pieces)
	USP	metric				
DS 30 ▼ 	2-0	3	0,75	grün / green	91412	36
	0	3.5	0,75	grün / green	91413	36
	1	4	0,75	grün / green	91428	36
DSM 30 ▽ 	2-0	3	0,75	grün / green	91521*	36
	0	3.5	0,75	grün / green	91522	36
PREMIUM-Schliff / <i>PREMIUM cut</i>						
DS 40 ▼ 	2-0	3	0,75	grün / green	91435*	36
	0	3.5	0,75	grün / green	91414	36
DS 50 ▼ 	1	4	0,75	grün / green	91434	36
GS = Gerade schneidend <i>GS = straight, cutting</i>						
GS 60 ▼ 	0	3.5	0,45	grün / green	9178*	36
	2-0	3	0,75	grün / green	9174*	36
	0	3.5	0,75	grün / green	9179	36
KS = 1/2-gebogene außen schneidend <i>KS = 1/2 curved, reverse cutting</i>						
KS 20 ▼ 	3-0	2	0,45	grün / green	9181*	36
HSPM = 1/2-Kreis SPATULA (PREMIUM-Schliff) <i>HSPM = 1/2 circle, spatulated (PREMIUM cut)</i>						
2 x HSPM 8 ▽ 	5-0	0.7	0,45	weiß / white	9192*	24
	4-0	1.5	0,45	weiß / white	9191	24
PREMIUM-Schliff / <i>PREMIUM cut</i>						
VSPM F = 1/4-Kreis SPATULA (PREMIUM-Schliff) <i>VSPM F = 1/4 circle, spatulated (PREMIUM cut)</i>						
2 x VSPM 8 F ▽ 	6-0	0.7	0,45	weiß / white	9211*	24
	5-0	1	0,45	weiß / white	9212	24
PREMIUM-Schliff / <i>PREMIUM cut</i>						

*eventuell mit verlängerter Lieferzeit verbunden / *possibly associated with an extended delivery time*

SUPOLENE

Einzelfadenpackungen, steril in vorgeschrittenen Längen / *Sterile pre-cut suture, non-needed*

Stärke / gauge USP metric		Länge / length (m)	Farbe / colour	Best.-Nr. / code no.	Packungsinhalt / box content (Stück / pieces)
3-0	2	5 x 0,35	grün / green	W453	24
2-0	3	5 x 0,35	grün / green	W553*	24
0	3.5	5 x 0,35	grün / green	W653	24
4-0	1.5	3 x 0,50	grün / green	W335*	24
3-0	2	3 x 0,50	grün / green	W435	24
2-0	3	3 x 0,50	grün / green	W535	24
0	3.5	3 x 0,50	grün / green	W635	24
1	4	3 x 0,50	grün / green	W735*	24
2	5	3 x 0,50	grün / green	W835	24
4-0	1.5	5 x 0,50	grün / green	W355*	24
3-0	2	5 x 0,50	grün / green	W455*	24
2-0	3	5 x 0,50	grün / green	W555	24
0	3.5	5 x 0,50	grün / green	W655*	24
1	4	5 x 0,50	grün / green	W755*	24
2	5	5 x 0,50	grün / green	W855*	24
4-0	1.5	6 x 0,50	grün / green	SW355	24
3-0	2	6 x 0,50	grün / green	SW455*	24
2-0	3	6 x 0,50	grün / green	SW555*	24
0	3.5	6 x 0,50	grün / green	SW655*	24
1	4	6 x 0,50	grün / green	SW755*	24
2	5	6 x 0,50	grün / green	SW855*	24
4-0	1.5	10 x 0,50	grün / green	W3105*	24
3-0	2	10 x 0,50	grün / green	W4105*	24
2-0	3	10 x 0,50	grün / green	W5105*	24
2-0	3	12 x 0,50	grün / green	SW5105*	24
0	3.5	12 x 0,50	grün / green	SW6105*	24
1	4	12 x 0,50	grün / green	SW7105*	24
3-0	2	17 x 0,50	grün / green	W4175*	24

*eventuell mit verlängerter Lieferzeit verbunden / *possibly associated with an extended delivery time*

SUPOLENE

Einzelfadenpackungen, steril in vorgeschnittenen Längen / *Sterile pre-cut suture, non-needed*

Stärke / USP	gauge metric	Länge / <i>length</i> (m)	Farbe / <i>colour</i>	Best.-Nr. / code no.	Packungsinhalt / <i>box content</i> (Stück / <i>pieces</i>)
2-0	3	2 x 0,75	grün / <i>green</i>	W520*	24
0	3.5	2 x 0,75	grün / <i>green</i>	W620*	24
1	4	2 x 0,75	grün / <i>green</i>	W720	24
2	5	2 x 0,75	grün / <i>green</i>	W820*	24
3	6	2 x 0,75	grün / <i>green</i>	W920*	24
1	4	5 x 0,75	grün / <i>green</i>	W750*	24
2	5	5 x 0,75	grün / <i>green</i>	W850*	24
3	6	5 x 0,75	grün / <i>green</i>	W950*	24

*eventuell mit verlängerter Lieferzeit verbunden / *possibly associated with an extended delivery time*

NYLON



- nicht-resorbierbares Material
- überdurchschnittlich geschmeidig und weich
- sehr gute Knüpfeigenschaften
- hervorragender Gewebedurchzug
- keine Kapillarität
- geringe Gewebereaktion

- *non-absorbable suture*
- *very soft and supple*
- *perfect handling and knotting*
- *easy passage through tissue*
- *no capillarity*
- *minimal tissue reactions*

NYLON

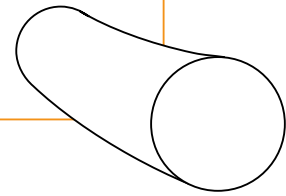

Eigenschaften:

- überdurchschnittlich weich und geschmeidig
- sehr gute Handhabungs- und Knüpf Eigenschaften
- keine Kapillarität
- hervorragendes Gewebedurchzugsverhalten

NYLON ist ein aus Polyamid 6-6.6 extrudierter (in formbarem Zustand durch Düsen gepresster und gereckter) monofiler Faden. Aufgrund der hohen Reißfestigkeit, selbst bei geringstem Fadendurchmesser, ist Nylon speziell für feinste Nähte in der Mikrochirurgie geeignet. Polyamide können bis zu 10% Wasser binden.

Das Material ist mit einem physiologisch unbedenklichen Farbstoff eingefärbt.

- Farbe: weiß (ohne Farbstoff), schwarz
- Chemische Bezeichnung: Polyamid 6-6.6
- Fadenstärke: USP 10-0 -2 (0.2-5 metric)
- Konfektionsangebote:
 - Nadel-Faden-Kombinationen
- Sterilisation: Ethylenoxid

Properties:

- above-average softness and suppleness
- superior handling and knotting properties
- no capillarity
- excellent tissue passage

NYLON is a monofilament extruded thread (pressed and drawn through dies in a malleable condition) made from polyamide 6-6.6.





Because of its high tensile strength, even when the fibre diameter is very fine, NYLON is particularly suitable for very fine suturing in microsurgery. Polyamides can bind up to 10% water.

The material is coloured with a physiologically safe dye.

- Colour: white (no dye), black
- Chemical name: polyamide 6-6.6
- Thread diameter: USP 10-0 -2 (0.2-5 metric)
- Types of packaging:
 - needle-thread-combinations
- Sterilization method: ethylene oxide

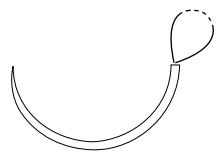
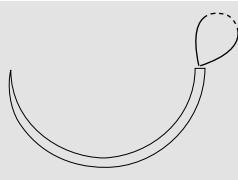
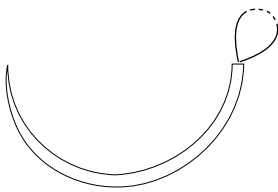
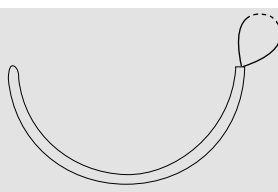
NYLON

Sterile Nadel-Faden-Kombination / *needle suture combination, sterile*

Nadel / needle	Stärke / gauge		Länge / length (m)	Farbe / colour	Best.-Nr. / code no.	Packungsinhalt / box content (Stück / pieces)
	USP	metric				
HR F, HRS, HRX = 1/2-Kreis Rundkörper <i>HR F, HRS, HRX = 1/2 circle, taper point</i>						
2 x HR 6 F ● 	10-0	0.2	0,10	schwarz / black	5021N ¹⁾	24
HRS 35 ● 	1	4	1,50	schwarz / black	5035*	24
HRS 40 ● 	0	3.5	1,50	schwarz / black	5033*	24
HRX 50 ● 	0	3.5	1,50	schwarz / black	5042*	24
	1	4	1,50	schwarz / black	5041*	24
HRN = 1/2-Kreis Rundkörper, stumpf <i>HRN = 1/2 circle, blunt taper point</i>						
HRN 50 ○ 	1	4	1,50	schwarz / black	5050*	24
HRT = 1/2-Kreis schneidende Rundkörper <i>HRT = 1/2 circle, taper cutting</i>						
HRT 18 ▼ 	4-0	1.5	0,75	schwarz / black	5061	36
DR, DR F = 3/8-Kreis Rundkörper <i>DR, DR F = 3/8 circle, taper point</i>						
DR 4 ● 	10-0	0.2	0,10	schwarz / black	50714N ¹⁾	24
DR 5 ● 	8-0	0.4	0,15	schwarz / black	50715N ¹⁾	24

*eventuell mit verlängerter Lieferzeit verbunden / *possibly associated with an extended delivery time*

NYLON

Sterile Nadel-Faden-Kombination / *needle suture combination, sterile*

Nadel / needle	Stärke / gauge		Länge / length (m)	Farbe / colour	Best.-Nr. / code no.	Packungsinhalt / box content (Stück / pieces)
	USP	metric				
DR 5 F ●	10-0	0.2	0,15	schwarz / black	5071N ¹⁾	24
		0.3				
2 x DR 5 F ●	10-0	0.2	0,15	schwarz / black	5073N ¹⁾	24
DR 6 ●	10-0	0.2	0,15	schwarz / black	5074N ¹⁾	24
		0.3				
		0.4				
2 x DR 6 ●	9-0	0.3	0,15	schwarz / black	5077N ¹⁾	24
DR 10 F ●	7-0	0.5	0,45	schwarz / black	5079*	36
DR 12 ●	5-0	1	0,75	schwarz / black	50712*	36
DR 12 F ●	6-0	0.7	0,75	schwarz / black	50711	36
DRTM = 3/8-Kreis schneidender Rundkörper, mit PREMIUM-Schliff <i>DRTM = 3/8 circle, taper cutting, PREMIUM cut</i>						
DRTM 5 PREMIUM-Schliff / PREMIUM cut	10-0	0.2	0,15	schwarz / black	5251*	24
HS, HSM = 1/2-Kreis außen schneidend, mit PREMIUM-Schliff <i>HS, HSM = 1/2 circle, reverse cutting, PREMIUM cut</i>						
2 x HSM 8 ▽ PREMIUM-Schliff / PREMIUM cut	9-0	0.3	0,45	schwarz / black	5121N ¹⁾	24
HS 12 ▼	5-0	1	0,45	schwarz / black	5111*	36
HSM 17 ▽ PREMIUM-Schliff / PREMIUM cut	4-0	1.5	0,45	schwarz / black	5126*	36

*eventuell mit verlängerter Lieferzeit verbunden / possibly associated with an extended delivery time

(M) = Multipack

NYLON











Sterile Nadel-Faden-Kombination / *needle suture combination, sterile*

Nadel / needle	Stärke / gauge		Länge / length (m)	Farbe / colour	Best.-Nr. / code no.	Packungsinhalt / box content (Stück / pieces)
	USP	metric				
DS, DS F = 3/8-Kreis außen schneidend DSM, DSM F = mit PREMIUM-Schliff <i>DS, DS F = 3/8 circle, reverse cutting</i> <i>DS, DSM F = PREMIUM cut</i>						
DSM 6 ▽ PREMIUM-Schliff / <i>PREMIUM cut</i>	10-0	0.2	0,30	schwarz / <i>black</i>	5152N ¹⁾	24
DSM 7 ▽ PREMIUM-Schliff / <i>PREMIUM cut</i>	7-0	0.5	0,45	schwarz / <i>black</i>	5155*	36
DSM 11 ▽ PREMIUM-Schliff / <i>PREMIUM cut</i>	7-0	0.5	0,45	schwarz / <i>black</i>	5156*	36
	6-0	0.7	0,45	schwarz / <i>black</i>	5157	36
DS 13 ▼	6-0	0.7	0,45	schwarz / <i>black</i>	5142	36
	5-0	1	0,45	schwarz / <i>black</i>	5143	36
	4-0	1.5	0,45	schwarz / <i>black</i>	5144	36
DSM 13 ▽ PREMIUM-Schliff / <i>PREMIUM cut</i>	6-0	0.7	0,45	schwarz / <i>black</i>	51540	36
	5-0	1	0,45	schwarz / <i>black</i>	51513	36
	4-0	1.5	0,45	schwarz / <i>black</i>	51514	36
DS 16 ▼	6-0	0.7	0,45	schwarz / <i>black</i>	5145	36
	5-0	1	0,45	schwarz / <i>black</i>	5146	36
DSM 16 ▽ PREMIUM-Schliff / <i>PREMIUM cut</i>	4-0	1.5	0,45	schwarz / <i>black</i>	51517	36
DSM 16 F ▽ PREMIUM-Schliff / <i>PREMIUM cut</i>	5-0	1	0,45	schwarz / <i>black</i>	51541	36
DS 18 ▼	5-0	1	0,45	schwarz / <i>black</i>	5147	36
	4-0	1.5	0,45	schwarz / <i>black</i>	5148	36
	3-0	2	0,45	schwarz / <i>black</i>	5149	36
	2-0	3	0,45	schwarz / <i>black</i>	51423*	36
	5-0	1	0,75	schwarz / <i>black</i>	51444	36
	4-0	1.5	0,75	schwarz / <i>black</i>	51445	36
	3-0	2	0,75	schwarz / <i>black</i>	51410	36
	4-0	1.5	0,45	weiß / <i>white</i>	51414	36
DS 18 F ▼	4-0	1.5	0,45	schwarz / <i>black</i>	51442	36
DSM 18 ▽ PREMIUM-Schliff / <i>PREMIUM cut</i>	5-0	1	0,45	schwarz / <i>black</i>	51518	36
	4-0	1.5	0,45	schwarz / <i>black</i>	51519	36
	3-0	2	0,45	schwarz / <i>black</i>	51520	36
	2-0	3	0,45	schwarz / <i>black</i>	51521*	36
	3-0	2	0,75	schwarz / <i>black</i>	51522*	36
DS 21 ▼	4-0	1.5	0,45	schwarz / <i>black</i>	51439	36
	3-0	2	0,45	schwarz / <i>black</i>	51440*	36
DS 24 ▼	3-0	2	0,45	schwarz / <i>black</i>	51415	36
	3-0	2	0,75	schwarz / <i>black</i>	51416	36

*eventuell mit verlängerter Lieferzeit verbunden / *possibly associated with an extended delivery time*

NYLON



Sterile Nadel-Faden-Kombination / *needle suture combination, sterile*

Nadel / needle	Stärke / gauge		Länge / length (m)	Farbe / colour	Best.-Nr. / code no.	Packungsinhalt / box content (Stück / pieces)
	USP	metric				
DSM 24  ▼ PREMIUM-Schliff / <i>PREMIUM cut</i>	3-0	2	0,45	schwarz / <i>black</i>	51523	36
	2-0	3	0,45	schwarz / <i>black</i>	51524	36
	3-0	2	0,75	schwarz / <i>black</i>	51535*	36
	2-0	3	0,75	schwarz / <i>black</i>	51536	36
DS 27 	2-0	3	0,45	schwarz / <i>black</i>	51419	36
DS 30 	0	3.5	0,45	schwarz / <i>black</i>	51421*	36
	2-0	3	0,75	schwarz / <i>black</i>	51454	36
HSPM, HSPM F = 1/2-Kreis SPATULA, PREMIUM-Schliff <i>HSPM, HSPM F= 1/2 circle, spatulated, PREMIUM cut</i>						
HSPM 6 F  ▼ PREMIUM-Schliff / <i>PREMIUM cut</i>	10-0	0.2	0,15	schwarz / <i>black</i>	51914N ¹⁾	24
	9-0	0.3	0,15	schwarz / <i>black</i>	51913N ¹⁾	24
2x HSPM 6 F  ▼ PREMIUM-Schliff / <i>PREMIUM cut</i>	10-0	0.2	0,30	schwarz / <i>black</i>	5198N ¹⁾	24
	9-0	0.3	0,30	schwarz / <i>black</i>	5199N ¹⁾	24
2 x HSPM 7  ▼ PREMIUM-Schliff / <i>PREMIUM cut</i>	10-0	0.2	0,30	schwarz / <i>black</i>	5193N ¹⁾	24
	9-0	0.3	0,30	schwarz / <i>black</i>	5194N ¹⁾	24
DSPM = 3/8-Kreis SPATULA PREMIUM-Schliff <i>DSPM= 3/8 circle, spatulated, PREMIUM cut</i>						
DSPM 4  ▼ PREMIUM-Schliff / <i>PREMIUM cut</i>	10-0	0.2	0,10	schwarz / <i>black</i>	52014N ¹⁾	24
DSPM 5  ▼ PREMIUM-Schliff / <i>PREMIUM cut</i>	10-0	0.2	0,30	schwarz / <i>black</i>	5201N ¹⁾	24
2 x DSPM 5  ▼ PREMIUM-Schliff / <i>PREMIUM cut</i>	10-0	0.2	0,30	schwarz / <i>black</i>	5202N ¹⁾	24
DSPM 6  ▼ PREMIUM-Schliff / <i>PREMIUM cut</i>	10-0	0.2	0,15	schwarz / <i>black</i>	5206N ¹⁾	24
	9-0	0.3	0,15	schwarz / <i>black</i>	52011N ¹⁾	24
	10-0	0.2	0,30	schwarz / <i>black</i>	52015N ¹⁾	24

*eventuell mit verlängerter Lieferzeit verbunden / *possibly associated with an extended delivery time*

NYLON

Sterile Nadel-Faden-Kombination / *needle suture combination, sterile*

Nadel / needle	Stärke / gauge		Länge / length (m)	Farbe / colour	Best.-Nr. / code no.	Packungsinhalt / box content (Stück / pieces)
	USP	metric				
2 x DSPM 6  PREMIUM-Schliff / PREMIUM cut	10-0	0.2	0,30	schwarz / black	5208N ¹⁾	24
2 x DSPM 7  PREMIUM-Schliff / PREMIUM cut	10-0	0.2	0,30	schwarz / black	5203N ¹⁾	24
	9-0	0.3	0,30	schwarz / black	5204N ¹⁾	24
VSPM = 1/4-Kreis SPATULA PREMIUM-Schliff <i>VSPM = 1/4 circle, spatulated,</i> <i>PREMIUM cut</i>						
2 x VSPM 7  PREMIUM-Schliff / PREMIUM cut	9-0	0.3	0,45	schwarz / black	5214*	244

*eventuell mit verlängerter Lieferzeit verbunden / *possibly associated with an extended delivery time*

¹⁾ Produkt hergestellt durch / *product manufactured by:*

 Healthium Medtech Private Limited (Formerly Sutures India Pvt. Ltd.)
No. 472/D, 13th Cross, 4th Phase - Peenya Industrial Area, Bangalore 560 058, India
Email: sales@suturesindia.com · Mfg. Lic. No.: KTK/28/283/96



- nicht-resorbierbares Material
- überdurchschnittlich geschmeidig und weich
- sehr gute Knüpfeigenschaften
- hervorragender Gewebedurchzug
- keine Kapillarität
- geringe Gewebereaktion

- *non-absorbable suture*
- *softer and more supple than average*
- *perfect handling and knotting*
- *easy passage through tissue*
- *no capillarity*
- *non-irritating*

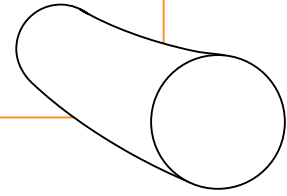

Eigenschaften:

- überdurchschnittlich weich und geschmeidig
- sehr gute Handhabungs- und Knüpfeigenschaften
- keine Kapillarität
- hervorragendes Gewebedurchzugsverhalten

RESOLON® ist zunächst, wie NYLON, ein monofiler Polyamid 6-6.6 Faden, der jedoch im Herstellungsprozess einer speziellen Behandlung unterzogen wird.

RESOLON® ist auch im trockenen sterilen Zustand überdurchschnittlich weich und geschmeidig. Dadurch ergeben sich für einen monofilen Faden hervorragende Handhabungs- und Knüpfeigenschaften bei optimaler Knotenreißkraft.

- Farbe: blau
- Chemische Bezeichnung: Polyamid 6-6.6
- Fadenstärke: USP 7-0 -1 (0.5-4 metric)
- Konfektionsangebote:
 - Nadel-Faden-Kombinationen
 - in vorgeschrittenen Längen
- Sterilisation: Ethylenoxid

Properties:

- above-average softness and suppleness
- superior handling and knotting properties
- no capillarity
- excellent tissue passage

RESOLON® is initially a monofilament polyamide 6-6.6 suture, like NYLON. However, it undergoes special treatment during the manufacturing process.











RESOLON® is exceptionally soft and supple even when dry and sterile.

As a result, it has excellent handling and knotting properties for a monofilament suture, while ensuring maximum knot tear resistance.

- Colour: blue
- Chemical name: polyamide 6-6.6
- Thread diameter: USP 7-0 -1 (0.5-4 metric)
- Types of packaging:
 - needle-thread-combinations
 - pre-cut lengths
- Sterilization method: ethylene oxide

RESOLON®









Sterile Nadel-Faden-Kombination / *needle suture combination, sterile*

Nadel / needle	Stärke / gauge		Länge / length (m)	Farbe / colour	Best.-Nr. / code no.	Packungsinhalt / box content (Stück / pieces)
	USP	metric				
HRT = 1/2-Kreis schneidende Rundkörper <i>HRT = 1/2 circle, taper cutting</i>						
HRT 18 ⊙ 	5-0	1	0,45	blau / blue	88062	36
	4-0	1.5	0,45	blau / blue	88061	36
HS = 1/2-Kreis außen schneidend HSM = mit PREMIUM-Schliff <i>HS = 1/2 circle, reverse cutting, HSM = PREMIUM cut</i>						
HS 12 ▼ 	5-0	1	0,45	blau / blue	88111	36
HSM 17 ▽ PREMIUM-Schliff / PREMIUM cut 	4-0	1.5	0,45	blau / blue	88121	36
HS 18 ▼ 	5-0	1	0,45	blau / blue	88112	36
	4-0	1.5	0,45	blau / blue	88113	36
	5-0	1	0,75	blau / blue	88116*	36
	4-0	1.5	0,75	blau / blue	88115	36
HS 22 ▼ 	3-0	2	0,45	blau / blue	88114	36
DS = 3/8-Kreis außen schneidend DSM, DSM F = mit PREMIUM-Schliff <i>DS = 3/8 circle, reverse cutting</i> <i>DSM, DSM F = PREMIUM cut</i>						
DSM 7 ▽ PREMIUM-Schliff / PREMIUM cut 	7-0	0.5	0,45	blau / blue	881543*	36
DSM 11 ▽ PREMIUM-Schliff / PREMIUM cut 	6-0	0.7	0,45	blau / blue	88151	36
	5-0	1	0,45	blau / blue	88152	36
DSM 11 F ▽ PREMIUM-Schliff / PREMIUM cut 	7-0	0.5	0,45	blau / blue	881528	36
	6-0	0.7	0,45	blau / blue	881549	36
DS 13 ▼ 	6-0	0.7	0,45	blau / blue	881430	36
	5-0	1	0,45	blau / blue	881431	36
	4-0	1.5	0,45	blau / blue	881432	36
DSM 13 ▽ PREMIUM-Schliff / PREMIUM cut 	6-0	0.7	0,45	blau / blue	88153	36
	5-0	1	0,45	blau / blue	88154	36
	4-0	1.5	0,45	blau / blue	881523	36
	6-0	0.7	0,75	blau / blue	881553	36
	5-0	1	0,75	blau / blue	881554*	36

*eventuell mit verlängerter Lieferzeit verbunden / *possibly associated with an extended delivery time*

RESOLON®

Sterile Nadel-Faden-Kombination / *needle suture combination, sterile*







Nadel / needle	Stärke / gauge USP	metric	Länge / length (m)	Farbe / colour	Best.-Nr. / code no.	Packungsinhalt / box content (Stück / pieces)			
DS 16 ▼		6-0	0,7	0,45	blau / blue	881440	36		
		5-0	1	0,45	blau / blue	88141	36		
		4-0	1,5	0,45	blau / blue	88142	36		
		3-0	2	0,45	blau / blue	881433	36		
		5-0	1	0,75	blau / blue	881451	36		
		4-0	1,5	0,75	blau / blue	881452	36		
		DSM 16 ▽ PREMIUM-Schliff / PREMIUM cut		6-0	0,7	0,45	blau / blue	881529	36
5-0	1	0,45		blau / blue	88155	36			
4-0	1,5	0,45		blau / blue	88156	36			
3-0	2	0,45		blau / blue	881548	36			
5-0	1,0	,75		blau / blue	881530	36			
4-0	1,5	0,75		blau / blue	881551	36			
3-0	2	0,75		blau / blue	881552*	36			
DSM 16 F ▽ PREMIUM-Schliff / PREMIUM cut		5-0	1	0,45	blau / blue	881550	36		
DS 18 ▼		5-0	1	0,45	blau / blue	88143	36		
		4-0	1,5	0,45	blau / blue	88144	36		
		3-0	2	0,45	blau / blue	88146	36		
		2-0	3	0,45	blau / blue	881454	36		
		5-0	1	0,75	blau / blue	881450	36		
		4-0	1,5	0,75	blau / blue	88145	36		
		3-0	2	0,75	blau / blue	88147	36		
		2-0	3	0,75	blau / blue	88148	36		
		4-0	1,5	4 x 0,45	blau / blue	M881421* (M)	24		
		DS 18 F ▼		4-0	1,5	0,45	blau / blue	881441	36
4-0	1,5	0,75		blau / blue	881442	36			
DSM 18 ▽ PREMIUM-Schliff / PREMIUM cut		5-0	1	0,45	blau / blue	88157	36		
		4-0	1,5	0,45	blau / blue	88158	36		
		3-0	2	0,45	blau / blue	881510	36		
		2-0	3	0,45	blau / blue	881531	36		
		5-0	1	0,75	blau / blue	881555	36		
		4-0	1,5	0,75	blau / blue	88159	36		
		3-0	2	0,75	blau / blue	881511	36		
		2-0	3	0,75	blau / blue	881512	36		
		DSM 18 F ▽ PREMIUM-Schliff / PREMIUM cut		4-0	1,5	0,45	blau / blue	881541	36
		4-0		1,5	0,75	blau / blue	881542	36	
DS 21 ▼		4-0	1,5	0,45	blau / blue	88149	36		
		3-0	2	0,45	blau / blue	881411	36		
		4-0	1,5	0,75	blau / blue	881410	36		
		3-0	2	0,75	blau / blue	881412	36		
		2-0	3	0,75	blau / blue	881413	36		

*eventuell mit verlängerter Lieferzeit verbunden / possibly associated with an extended delivery time

(M) = Multipack

RESOLON®



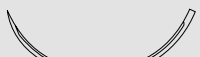

Sterile Nadel-Faden-Kombination / *needle suture combination, sterile*

Nadel / needle	Stärke / gauge USP	metric	Länge / length (m)	Farbe / colour	Best.-Nr. / code no.	Packungsinhalt / box content (Stück / pieces)
DSM 21  PREMIUM-Schliff / <i>PREMIUM cut</i>	4-0	1.5	0,45	blau / blue	881513	36
	3-0	2	0,45	blau / blue	881515	36
	4-0	1.5	0,75	blau / blue	881514	36
	3-0	2	0,75	blau / blue	881516	36
	2-0	3	0,75	blau / blue	881517	36
DS 24  	5-0	1	0,45	blau / blue	881458	36
	4-0	1.5	0,45	blau / blue	881424	36
	3-0	2	0,45	blau / blue	881414	36
	2-0	3	0,45	blau / blue	881425	36
	4-0	1.5	0,75	blau / blue	881457	36
	3-0	2	0,75	blau / blue	881415	36
	2-0	3	0,75	blau / blue	881416	36
DSM 24  PREMIUM-Schliff / <i>PREMIUM cut</i>	4-0	1.5	0,45	blau / blue	881544	36
	3-0	2	0,45	blau / blue	881518	36
	2-0	3	0,45	blau / blue	881524	36
	4-0	1.5	0,75	blau / blue	881545	36
	3-0	2	0,75	blau / blue	881519	36
	2-0	3	0,75	blau / blue	881520	36
DS 27  	3-0	2	0,45	blau / blue	881453	36
	2-0	3	0,45	blau / blue	881423	36
	0	3.5	0,45	blau / blue	881456	36
	3-0	2	0,75	blau / blue	881417	36
	2-0	3	0,75	blau / blue	881418	36
	0	3.5	0,75	blau / blue	881459*	36
	2-0	3	0,75	blau / blue	881526*	36
DSM 27  PREMIUM-Schliff / <i>PREMIUM cut</i>	2-0	3	0,45	blau / blue	881525*	36
	2-0	3	0,75	blau / blue	881526*	36
DS 30  	4-0	1.5	0,45	blau / blue	881434	36
	3-0	2	0,45	blau / blue	881426	36
	2-0	3	0,45	blau / blue	881428	36
	0	3.5	0,45	blau / blue	881429	36
	4-0	1.5	0,75	blau / blue	881435*	36
	3-0	2	0,75	blau / blue	881427	36
	2-0	3	0,75	blau / blue	881419	36
	0	3.5	0,75	blau / blue	881420	36
DSM 30  PREMIUM-Schliff / <i>PREMIUM cut</i>	3-0	2	0,45	blau / blue	881532	36
	2-0	3	0,45	blau / blue	881534	36
	0	3.5	0,45	blau / blue	881536*	36
	3-0	2	0,75	blau / blue	881533	36
	2-0	3	0,75	blau / blue	881535	36
	0	3.5	0,75	blau / blue	881537	36

*eventuell mit verlängerter Lieferzeit verbunden / *possibly associated with an extended delivery time*

RESOLON®

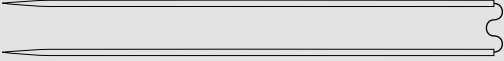
Sterile Nadel-Faden-Kombination / *needle suture combination, sterile*

Nadel / needle	Stärke / gauge		Länge / length (m)	Farbe / colour	Best.-Nr. / code no.	Packungsinhalt / box content (Stück / pieces)
	USP	metric				
DS 40 	2-0	3	0,45	blau / blue	881436	36
	0	3.5	0,45	blau / blue	881438*	36
	3-0	2	0,75	blau / blue	881443	36
	2-0	3	0,75	blau / blue	881437	36
	0	3.5	0,75	blau / blue	881439	36
	2-0	3	0,90	blau / blue	881455	36
DSM 40  PREMIUM-Schliff / <i>PREMIUM cut</i>	2-0	3	0,75	blau / blue	881538*	36
	0	3.5	0,75	blau / blue	881540*	36
GR = Gerade Rundkörper <i>GR = straight, taper point</i>						
GR 20 	4-0	1.5	0,45	blau / blue	88093	36
GRW = Gerade Rundkörper, biegsame Nadel <i>GRW = straight, taper point, flexible needle</i>						
2 x GRW 65  ● Biegsame Nadel / <i>Flexible needle</i>	2-0	3	0,75	blau / blue	88091	36
	0	3.5	0,75	blau / blue	88092	36
GS = Gerade schneidend <i>GS = Straight cutting</i>						
GS 60 	3-0	2	0,75	blau / blue	88171*	36
	2-0	3	0,75	blau / blue	88172	36

*eventuell mit verlängerter Lieferzeit verbunden / *possibly associated with an extended delivery time*

RESOLON®

Einzelfadenpackungen, steril in vorgeschnittenen Längen / *Sterile pre-cut suture, non-needed*

Stärke / <i>gauge</i> USP	<i>metric</i>	Länge / <i>length</i> (m)	Farbe / <i>colour</i>	Best.-Nr. / <i>code no.</i>	Packungsinhalt / <i>box content</i> (Stück / <i>pieces</i>)
4-0	1.5	3 x 0,50	blau / <i>blue</i>	X335N*	24
3-0	2	3 x 0,50	blau / <i>blue</i>	X435N*	24
2-0	3	3 x 0,50	blau / <i>blue</i>	X535N*	24
0	3.5	3 x 0,50	blau / <i>blue</i>	X635N*	24
3-0	2	10 x 0,50	blau/blue	X4105N*	24

*eventuell mit verlängerter Lieferzeit verbunden / *possibly associated with an extended delivery time*



- nicht-resorbierbarer Polyamid-Faden
- sehr geschmeidig
- zugfest
- geringe Gewebereaktion
- gute Knoteneigenschaften

- *non-absorbable polyamide-suture*
- *very soft*
- *high tensile strength*
- *less tissue reaction*
- *good knotting properties*

SUPRAMID

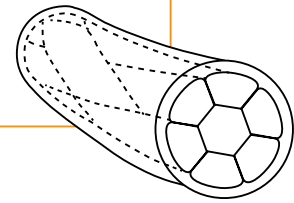

Eigenschaften:

- überdurchschnittlich weich und geschmeidig
- sehr gute Handhabungs- und Knüpfeigenschaften
- keine Kapillarität
- hervorragendes Gewebedurchzugsverhalten

SUPRAMID ist als monofiles, nicht-resorbierbares, chirurgisches Nahtmaterial aus einem Copolymerisat aus Polyamid 6 und Polyamid 6.6 erhältlich. In stärkeren Durchmessern wird es als pseudomonofiles

nicht-resorbierbares, chirurgisches Nahtmaterial aus Polyamid 6.6, einem Polymer von Hexamethylen-diamin und Adipinsäure, mit einer Beschichtung aus Polyamid 6, einem ϵ -Caprolactam-Polymer, angeboten.

Besonderheit

Trotz seiner synthetischen Herkunft, bedingt durch die peptidartige Struktur, unterliegt SUPRAMID nach längerem Verbleib im Gewebe der allmählichen Degradation und ist daher mit wenigen Ausnahmen nur für Hautnähte oder Gewebe, die keine permanenten Wundunterstützungen benötigen, geeignet.

Das Material ist mit einem physiologisch unbedenklichen Farbstoff eingefärbt.

- Farbe: weiß (ohne Farbstoff) oder schwarz
- Chemische Bezeichnung: monofil: Polyamid 6-6.6 pseudomonofil: Polyamid 6.6 und Polyamid 6
- Fadenstärke: USP 6-0 -2 (0.7-5 metric)
- Konfektionsangebote:
 - Nadel-Faden-Kombinationen
 - in vorgeschrittenen Längen
- Sterilisation: Ethylenoxid

Properties:

- above-average softness and suppleness
- superior handling and knotting properties
- no capillarity
- excellent tissue passage

SUPRAMID is available as a monofilament, non-absorbable, surgical suture made from a copolymer of polyamide 6 and polyamide 6.6. In larger diameters, it is supplied as

a pseudo-monofilament, non-absorbable, surgical suture made from polyamide 6.6, a polymer of hexamethylenediamine and adipic acid with a polyamide-6 coating, a polymer of ϵ -caprolactam.

Special feature







The peptide structure of SUPRAMID allows it to degrade gradually after it has remained in the tissue for a while, despite its synthetic origin. This suture is therefore, with few exceptions, only suitable for skin sutures or for tissue that does not require permanent support.

The material is coloured with a physiologically harmless dye.

- Colour: white (no dye) or black
- Chemical name: monofilament: polyamide 6-6.6 pseudomonofilament: polyamide 6.6 and polyamide 6
- Thread diameter: USP 6-0 -2 (0.7-5 metric)
- Types of packaging:
 - needle-thread-combinations
 - in pre-cut lengths
- Sterilization method: ethylene oxide

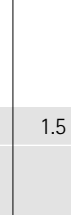
SUPRAMID









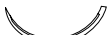
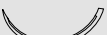

Sterile Nadel-Faden-Kombination / *needle suture combination, sterile*

Nadel / needle	Stärke / gauge		Länge / length (m)	Farbe / colour	Best.-Nr. / code no.	Packungsinhalt / box content (Stück / pieces)
	USP	metric				
HRT = 1/2-Kreis schneidende Rundkörper						
<i>HRT = 1/2 circle, taper cutting</i>						
HRT 18 	4-0	1.5	0,50	schwarz / black	6061	36
	3-0	2	0,50	schwarz / black	6062	36
	4-0	1.5	0,75	schwarz / black	6063	36
	3-0	2	0,75	schwarz / black	6064	36
DR = 3/8-Kreis Rundkörper						
<i>DR = 3/8 circle, taper point</i>						
DR 18 	4-0	1.5	0,50	weiß / white	6070	36
DRT = 3/8-Kreis schneidende Rundkörper						
<i>DRT = 3/8 circle, taper cutting</i>						
DRT 18 	4-0	1.5	0,50	weiß / white	6080	36
HS = 1/2-Kreis außen schneidend						
<i>HS = 1/2 circle, reverse cutting</i>						
HS 15 	4-0	1.5	0,45	schwarz / black	6118	36
	3-0	2	0,45	schwarz / black	6119	36
	4-0	1.5	0,75	schwarz / black	61112*	36
HS 18 	5-0	1	0,45	schwarz / black	6111	36
	4-0	1.5	0,45	schwarz / black	6112	36
	3-0	2	0,45	schwarz / black	6114	36
	4-0	1.5	0,75	schwarz / black	61111	36
	3-0	2	0,75	schwarz / black	6117	36
HS 20 	3-0	2	0,45	schwarz / black	61113	36
	4-0	1.5	0,75	schwarz / black	61110	36
	3-0	2	0,75	schwarz / black	6116	36
HS 22 	3-0	2	0,45	schwarz / black	6113	36
	3-0	2	0,75	schwarz / black	61114	36
	2-0	3	0,75	schwarz / black	6115*	36

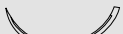
*eventuell mit verlängerter Lieferzeit verbunden / *possibly associated with an extended delivery time*

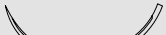
SUPRAMID

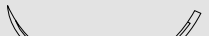
Sterile Nadel-Faden-Kombination / *needle suture combination, sterile*







Nadel / needle	Stärke / gauge		Länge / length (m)	Farbe / colour	Best.-Nr. / code no.	Packungsinhalt / box content (Stück / pieces)	
	USP	metric					
DS = 3/8-Kreis außen schneidend DSM = mit PREMIUM-Schliff <i>DS = 3/8 circle, reverse cutting</i> <i>DSM = PREMIUM cut</i>							
DSM 11 ▽ PREMIUM-Schliff / PREMIUM cut		6-0	0,7	0,45	schwarz / black	6151	36
		5-0	1	0,45	schwarz / black	6152	36
DS 13 ▼		5-0	1	0,45	schwarz / black	6141	36
		5-0	1	0,75	schwarz / black	61410	36
DSM 13 ▽ PREMIUM-Schliff / PREMIUM cut		5-0	1	0,45	schwarz / black	6158*	36
		4-0	1,5	0,45	schwarz / black	6154	36
DS 16 ▼		4-0	1,5	0,45	schwarz / black	61432	36
DSM 16 ▽ PREMIUM-Schliff / PREMIUM cut		5-0	1	0,45	schwarz / black	6157	36
		4-0	1,5	0,75	schwarz / black	6153	36
DS 18 ▼		4-0	1,5	0,45	schwarz / black	6142	36
		3-0	2	0,45	schwarz / black	6143	36
		4-0	1,5	0,75	schwarz / black	61428	36
		3-0	2	0,75	schwarz / black	61429	36
		3-0	2	6 x 0,45	schwarz / black	6144* (M)	12
		4-0	1,5	0,45	weiß / white	61430	36
		3-0	2	0,45	weiß / white	61431*	36
DS 18 F ▼		4-0	1,5	0,45	schwarz / black	61420	36
DSM 18 ▽ PREMIUM-Schliff / PREMIUM cut		4-0	1,5	0,75	schwarz / black	6155*	36
		3-0	2	0,75	schwarz / black	6156*	36
DS 24 ▼		4-0	1,5	0,45	schwarz / black	6146*	36
		3-0	2	0,45	schwarz / black	6147	36
		2-0	3	0,45	schwarz / black	61422	36
		3-0	2	0,75	schwarz / black	61425	36
		3-0	2	6 x 0,45	schwarz / black	6148* (M)	12
		3-0	2	0,45	schwarz / black	61418*	36
DS 24 F ▼		5-0	1	0,45	schwarz / black	61418*	36
DS 30 ▼		2-0	3	0,45	schwarz / black	6149	36
		0	3,5	0,45	schwarz / black	61423	36
		2-0	3	0,75	schwarz / black	61426	36
		0	3,5	0,75	schwarz / black	61427	36
		2-0	3	0,45	schwarz / black	61421	36
DS 40 ▼		3-0	2	0,45	schwarz / black	61412*	36
		2-0	2,5	0,45	schwarz / black	61413*	36
		0	3,5	0,75	weiß / white	61421	36

*eventuell mit verlängerter Lieferzeit verbunden / possibly associated with an extended delivery time

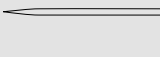
(M) = Multipack

SUPRAMID

Sterile Nadel-Faden-Kombination / *needle suture combination, sterile*

Nadel / needle	Stärke / gauge		Länge / length (m)	Farbe / colour	Best.-Nr. / code no.	Packungsinhalt / box content (Stück / pieces)
	USP	metric				
GR = Gerade Rundkörper						
<i>GR= straight, taper point</i>						
GR 20 	5-0	1.5	0,45	schwarz / black	6091	36
	4-0	1	0,45	schwarz / black	6090	36
	4-0	1.5	0,75	schwarz / black	6092	36
VSPM, VSPM F = 1/4-Kreis SPATULA						
PREMIUM-Schliff						
<i>VSPM, VSPM F = 1/4 circle, spatulated, PREMIUM cut</i>						
VSPM 8 	4-0	1.5	0,75	weiß / white	6211*	24
	 PREMIUM-Schliff / <i>PREMIUM cut</i>					
2x VSPM 8 	4-0	1.5	0,25	weiß / white	6213*	24
	 PREMIUM-Schliff / <i>PREMIUM cut</i>					
2 x VSPM 8 F 	5-0	1	0,45	weiß / white	6212*	24
	 PREMIUM-Schliff / <i>PREMIUM cut</i>					

*eventuell mit verlängerter Lieferzeit verbunden / *possibly associated with an extended delivery time*

SUPRAMID

Einzelfadenpackungen, steril in vorgeschrittenen Längen / *Sterile pre-cut suture, non-needed*

Stärke / <i>gauge</i> USP		Länge / <i>length</i> (m)	Farbe / <i>colour</i>	Best.-Nr. / <i>code no.</i>	Packungsinhalt / <i>box content</i> (Stück / <i>pieces</i>)
4-0	1.5	3 x 0,50	schwarz / <i>black</i>	SAM335*	24
3-0	2	3 x 0,50	schwarz / <i>black</i>	SAM435*	24
2-0	3	3 x 0,50	schwarz / <i>black</i>	SAM535*	24
0	3.5	3 x 0,50	schwarz / <i>black</i>	SAM635*	24
1	4	3 x 0,50	schwarz / <i>black</i>	SAM735*	24
4-0	1.5	3 x 0,50	weiß / <i>white</i>	M335*	24
3-0	2	3 x 0,50	weiß / <i>white</i>	M435*	24
2-0	3	3 x 0,50	weiß / <i>white</i>	M535*	24
0	3.5	3 x 0,50	weiß / <i>white</i>	M635*	24
1	4	3 x 0,50	weiß / <i>white</i>	M735*	24
4-0	1.5	5 x 0,50	schwarz / <i>black</i>	SAM355	24
3-0	2	5 x 0,50	schwarz / <i>black</i>	SAM455	24
2-0	3	5 x 0,50	schwarz / <i>black</i>	SAM555*	24
0	3.5	5 x 0,50	schwarz / <i>black</i>	SAM655*	24
3-0	2	5 x 0,50	weiß / <i>white</i>	M455*	24
2-0	3	5 x 0,50	weiß / <i>white</i>	M555*	24
0	3.5	5 x 0,50	weiß / <i>white</i>	M655*	24
3-0	2	10 x 0,50	schwarz / <i>black</i>	SAM4105*	24
3-0	2	10 x 0,50	weiß / <i>white</i>	M4105*	24
2-0	3	10 x 0,50	weiß / <i>white</i>	M5105*	24

*eventuell mit verlängerter Lieferzeit verbunden / *possibly associated with an extended delivery time*



- nicht-resorbierbarer Seidenfaden
- hohe Geschmeidigkeit
- hervorragendes Knüpfverhalten
- maximale Zugfestigkeit

- *non-absorbable suture*
- *permanent pliability*
- *perfect knot security*
- *maximum tensile strength*

SEIDE / SILK

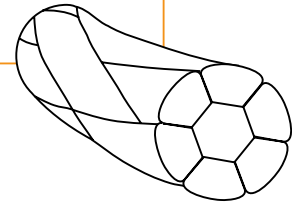

Eigenschaften:

- hohe Geschmeidigkeit
- hervorragendes Knüpfverhalten
- guter Knotensitz
- geringe Sägewirkung

Der Rohstoff für die Seidenherstellung ist das Gespinst (Kokon) der Seidenspinnerraupe.

Diese feinsten Kokonfäden werden entbastet (von der Kittsubstanz Sericin befreit), versponnen und präzisionsgeflochten.

Durch Oberflächenbehandlung wird der Seidenfaden imprägniert. Man erhält damit eine Seide ohne unerwünschte Dochtwirkung, also einen nichtkapillaren, Wasser abstoßenden Faden mit glatter Oberfläche. Schwarze SEIDE ist mit einem physiologisch unbedenklichen Farbstoff eingefärbt.

- Farbe: weiß (ohne Farbstoff) oder schwarz
- Chemische Bezeichnung: Seidenfibroin
- Fadenstärke: USP 10-0 -5 (0.2-7 metric)
- Konfektionsangebote:
 - Nadel-Faden-Kombinationen
 - in vorgeschrittenen Längen
- Sterilisation: Ethylenoxid

Properties:

- *very supple*
- *excellent knotting properties*
- *excellent knot security*
- *minimal sawing effect*

The raw material for producing silk is the cocoon of the silkworm.













These very fine silk filaments undergo degumming (removing sericin, a viscous binding protein), spinning and precision-braiding.

A surface treatment waterproofs the silk filament. This process results in silk without any undesirable wicking, i.e. a non-capillary, hydrophobic suture with a smooth surface. The black SILK is coloured with a physiologically harmless dye.

- *Colour: white (without dye) or black*
- *Chemical name: silk fibroin*
- *Thread diameter: USP 10-0 -5 (0.2-7 metric)*
- *Types of packaging:*
 - *needle-thread-combinations*
 - *precut lengths*
- *Sterilization method: ethylene oxide*

SEIDE / SILK

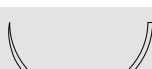
Sterile Nadel-Faden-Kombination / *needle suture combination, sterile*









Nadel / needle	Stärke / gauge USP	metric	Länge / length (m)	Farbe / colour	Best.-Nr. / code no.	Packungsinhalt / box content (Stück / pieces)
HR, HRS = 1/2-Kreis Rundkörper <i>HR, HRS = 1/2 circle, taper point</i>						
HR 10 ● 	5-0	1	0,45	schwarz / black	4021*	36
HR 12 ● Abziehnadel / <i>control release needle</i> 	5-0	1	0,45	schwarz / black	4023*	36
	4-0	1.5	0,45	schwarz / black	4024	36
HR 12 A ● 	4-0	1.5	8 x 0,45	schwarz / black	A40248 (M)	12
	3-0	2	8 x 0,45	schwarz / black	A40264 (M)	12
HR 17 ● 	5-0	1	0,75	schwarz / black	4026	36
	4-0	1.5	0,75	schwarz / black	4027	36
	3-0	2	0,45	schwarz / black	40267	36
	3-0	2	0,75	schwarz / black	4028	36
	2-0	3	0,75	schwarz / black	4029	36
HR 17 A ● Abziehnadel / <i>control release needle</i> 	4-0	1.5	8 x 0,45	schwarz / black	A40249* (M)	12
	3-0	2	8 x 0,45	schwarz / black	A40250 (M)	12
	2-0	3	8 x 0,45	schwarz / black	A40265 (M)	12
2 x HR 17 ● 	4-0	1.5	0,75	schwarz / black	40215*	36
	3-0	2	0,75	schwarz / black	40216*	36
	2-0	3	0,75	schwarz / black	40217*	36
HR 22 ● 	4-0	1.5	0,75	schwarz / black	40219	36
	3-0	2	0,75	schwarz / black	40220	36
	2-0	3	0,75	schwarz / black	40221	36
HR 22 A ● Abziehnadel / <i>control release needle</i> 	3-0	2	8 x 0,45	schwarz / black	A40252* (M)	12
	2-0	3	8 x 0,45	schwarz / black	A40253* (M)	12
HR 27 ● 	4-0	1.5	0,75	schwarz / black	40225*	36
	3-0	2	0,75	schwarz / black	40226	36
	2-0	3	0,75	schwarz / black	40227	36
	0	3.5	0,75	schwarz / black	40228	36
	1	4	0,75	schwarz / black	40229*	36
HR 27 A ● Abziehnadel / <i>control release needle</i> 	2-0	3	8 x 0,45	schwarz / black	A40259* (M)	12
HR 30 ● 	2-0	3	0,75	schwarz / black	40238	36
	0	3.5	0,75	schwarz / black	40239*	36
HR 35 ● 	2-0	3	0,75	schwarz / black	40242*	36
	0	3.5	0,75	schwarz / black	40243	36
	1	4	0,75	schwarz / black	40244*	36
	2	5	0,75	schwarz / black	40245	36

*eventuell mit verlängerter Lieferzeit verbunden / *possibly associated with an extended delivery time*

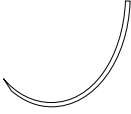
(M) = Multipack

SEIDE / SILK

Sterile Nadel-Faden-Kombination / *needle suture combination, sterile*

Nadel / needle	Stärke / gauge USP metric	Länge / length (m)	Farbe / colour	Best.-Nr. / code no.	Packungsinhalt / box content (Stück / pieces)	
HRS 35 ● 	0	3.5	0,75	schwarz / black	4031*	36
HR 40 ● 	1	4	0,75	schwarz / black	40247	36
ART = Asymptotische schneidende Rundkörper <i>ART= asymptotic, taper cutting</i>						
ART 13 ▼ 	4-0	1.5	0,45	schwarz / black	4281*	12
ART 25 ▼ 	4-0	1.5	0,45	schwarz / black	4282	12
	3-0	2	0,45	schwarz / black	4283	12
HRT = 1/2-Kreis schneidende Rundkörper <i>HRT = 1/2 circle, taper cutting</i>						
HRT 18 ▼ 	4-0	1.5	0,45	schwarz / black	40616	36
	3-0	2	0,45	schwarz / black	40615	36
	2-0	3	0,45	schwarz / black	40617	36
	3-0	2	6 x 0,45	schwarz / black	40618 (M)	12
	4-0	1.5	0,75	schwarz / black	4062	36
	3-0	2	0,75	schwarz / black	4063	36
	2-0	3	0,75	schwarz / black	4064	36
HRT 25 ▼ 	3-0	2	0,75	schwarz / black	40610	36
	2-0	3	0,75	schwarz / black	40611	36
DR, DR F = 3/8-Kreis Rundkörper <i>DR, DR F = 3/8 circle, taper point</i>						
DR 10 F ● 	7-0	0.5	0,30	schwarz / black	4071*	24
	6-0	0.7	0,45	schwarz / black	4072	24
DR 12 ● 	5-0	1	0,75	schwarz / black	4078*	36
	4-0	1.5	0,75	schwarz / black	4079*	36
2 x DR 12 ● 	5-0	1	0,45	schwarz / black	40712*	36

*eventuell mit verlängerter Lieferzeit verbunden / *possibly associated with an extended delivery time*

(M) = Multipack

SEIDE / SILK

Sterile Nadel-Faden-Kombination / *needle suture combination, sterile*











Nadel / needle	Stärke / gauge USP	gauge metric	Länge / length (m)	Farbe / colour	Best.-Nr. / code no.	Packungsinhalt / box content (Stück / pieces)
DR 12 F ●	6-0	0.7	0,45	schwarz / black	4077*	36
DR 18 ●	3-0	2	0,30	schwarz / black	40725	36
DRN = 3/8-Kreis Rundkörper stumpf <i>DRN = 3/8 circle, blunt taper point</i>						
DRN 17	3-0	2	0,30	schwarz / black	4273*	36
	3-0	2	2 x 0,75	schwarz / black	4272 (M)	24
DRT = 3/8-Kreis schneidende Rundkörper <i>DRT = 3/8 circle, taper cutting</i>						
DRT 18 ⊙	3-0	2	0,75	schwarz / black	4083	36
GR = Gerade Rundkörper <i>GR = straight, taper point</i>						
GR 20 ●	4-0	1.5	0,45	schwarz / black	40918	36
	4-0	1.5	0,75	schwarz / black	4091	36
GR 45 ●	3-0	2	0,75	schwarz / black	4095*	36
HS = 1/2-Kreis außen schneidend HSM, HSM F = mit PREMIUM-Schliff <i>HS = 1/2 circle, reverse cutting</i> <i>HSM, HSM F = PREMIUM cut</i>						
2 x HSM 9 S ▽ PREMIUM-Schliff / PREMIUM cut	4-0	1.5	0,45	schwarz / black	4125*	24
2 x HSM 10 ▽ PREMIUM-Schliff / PREMIUM cut	6-0	0.7	0,45	schwarz / black	4130N ¹⁾	24
HS 12 ▼	5-0	1	0,45	schwarz / black	4111	36
HSM 13 ▽ PREMIUM-Schliff / PREMIUM cut	5-0	1	0,45	schwarz / black	41210	36
	4-0	1.5	0,45	schwarz / black	41211	36

*eventuell mit verlängerter Lieferzeit verbunden / possibly associated with an extended delivery time

(M) = Multipack

SEIDE / SILK











Sterile Nadel-Faden-Kombination / *needle suture combination, sterile*

Nadel / needle	Stärke / gauge		Länge / length (m)	Farbe / colour	Best.-Nr. / code no.	Packungsinhalt / box content (Stück / pieces)
	USP	metric				
HS 18 	5-0	1	0,45	schwarz / black	4118	36
	4-0	1.5	0,45	schwarz / black	4112	36
	3-0	2	0,45	schwarz / black	4113	36
	5-0	1	0,75	schwarz / black	41112	36
	4-0	1.5	0,75	schwarz / black	4119	36
	3-0	2	0,75	schwarz / black	41111*	36
HS 22 	3-0	2	0,45	schwarz / black	4116	36
	2-0	3	0,45	schwarz / black	4117	36
	3-0	2	0,75	schwarz / black	41113	36
HS 35 	2-0	3	0,75	schwarz / black	41110*	36
DR = 3/8-Kreis Rundkörper <i>DR = 3/8 circle, taper point</i>						
DR 18 	5-0	1	0,75	schwarz / black	40728	36
	4-0	1.5	0,75	schwarz / black	40727	36
DS = 3/8-Kreis außen schneidend DSM, DSM F = mit PREMIUM-Schliff <i>DS = 3/8 circle, reverse cutting</i> <i>DSM, DSM F = PREMIUM cut</i>						
DSM 6 	8-0	0.4	0,30	schwarz / black	4154N ¹⁾	24
	▽ PREMIUM-Schliff / PREMIUM cut					
DSM 7 F 	7-0	0.5	0,30	schwarz / black	4157N ¹⁾	24
	▽ PREMIUM-Schliff / PREMIUM cut					
2 x DSM 7 F 	7-0	0.5	0,45	schwarz / black	4159N ¹⁾	24
	▽ PREMIUM-Schliff / PREMIUM cut					
DSM 11 	6-0	0.7	0,45	schwarz / black	41517	36
	▽ PREMIUM-Schliff / PREMIUM cut					
DSM 11 F 	6-0	0.7	0,45	schwarz / black	41538	36
	▽ PREMIUM-Schliff / PREMIUM cut					
2 x DSM 11 F 	6-0	0.7	0,45	schwarz / black	41519	36
	▽ PREMIUM-Schliff / PREMIUM cut					
DS 13 	6-0	0.7	0,35	schwarz / black	4141	36
	5-0	1	0,45	schwarz / black	4142	36
	4-0	1.5	0,45	schwarz / black	4143	36

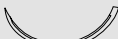
*eventuell mit verlängerter Lieferzeit verbunden / possibly associated with an extended delivery time

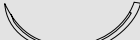
SEIDE / SILK

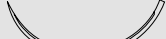

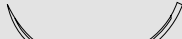





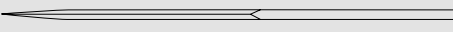

Sterile Nadel-Faden-Kombination / *needle suture combination, sterile*

Nadel / needle	Stärke / gauge USP	metric	Länge / length (m)	Farbe / colour	Best.-Nr. / code no.	Packungsinhalt / box content (Stück / pieces)
2 x DS 13 ▼ 	5-0	1	0,35	schwarz / black	4145*	36
	4-0	1.5	0,35	schwarz / black	4146*	36
	6-0	0.7	0,45	schwarz / black	4144*	36
DSM 13 ▽ PREMIUM-Schliff / PREMIUM cut 	6-0	0.7	0,45	schwarz / black	41542	36
	5-0	1	0,45	schwarz / black	41520	36
	4-0	1.5	0,45	schwarz / black	41521	36
DS 16 ▼ 	6-0	0.7	0,45	schwarz / black	4147*	36
	5-0	1	0,45	schwarz / black	4148	36
	4-0	1.5	0,45	schwarz / black	4149	36
DSM 16 ▽ PREMIUM-Schliff / PREMIUM cut 	5-0	1	0,45	schwarz / black	41524*	36
	4-0	1.5	0,45	schwarz / black	41525	36
DS 18 ▼ 	5-0	1	0,45	schwarz / black	41411	36
	4-0	1.5	0,45	schwarz / black	41412	36
	3-0	2	0,45	schwarz / black	41413	36
	4-0	1.5	0,75	schwarz / black	41414	36
	3-0	2	0,75	schwarz / black	41438	36
DSM 18 ▽ PREMIUM-Schliff / PREMIUM cut 	4-0	1.5	0,45	schwarz / black	41527	36
	3-0	2	0,45	schwarz / black	41528*	36
	2-0	3	0,45	schwarz / black	41529*	36
DS 21 ▼ 	4-0	1.5	0,45	schwarz / black	41431	36
	3-0	2	0,45	schwarz / black	41432	36
	2-0	3	0,45	schwarz / black	41433*	36
DSM 21 ▽ PREMIUM-Schliff / PREMIUM cut 	4-0	1.5	0,45	schwarz / black	41534*	36
	3-0	2	0,45	schwarz / black	41535*	36
	2-0	3	0,45	schwarz / black	41536	36
DS 24 ▼ 	4-0	1.5	0,45	schwarz / black	41416*	36
	3-0	2	0,45	schwarz / black	41417	36
	2-0	3	0,45	schwarz / black	41418	36
	3-0	2	0,75	schwarz / black	41419	36
	2-0	3	0,75	schwarz / black	41436	36
DSM 24 ▽ PREMIUM-Schliff / PREMIUM cut 	2-0	3	0,45	schwarz / black	41533*	36
	3-0	2	0,45	schwarz / black	41532*	36
	2-0	3	0,75	schwarz / black	41531*	36
DS 27 ▼ 	2-0	3	0,45	schwarz / black	41422	36

*eventuell mit verlängerter Lieferzeit verbunden / possibly associated with an extended delivery time

SEIDE / SILK

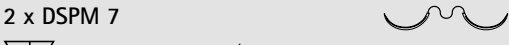

Sterile Nadel-Faden-Kombination / *needle suture combination, sterile*

Nadel / needle	Stärke / gauge		Länge / length (m)	Farbe / colour	Best.-Nr. / code no.	Packungsinhalt / box content (Stück / pieces)
	USP	metric				
DS 30 	3-0	2	0,45	schwarz / black	41423	36
	2-0	3	0,45	schwarz / black	41424	36
	0	3.5	0,45	schwarz / black	41425	36
	2-0	3	0,75	schwarz / black	41426	36
	0	3.5	0,75	schwarz / black	41428	36
	1	4	0,75	schwarz / black	41439	36
DS 40 	0	3.5	0,75	schwarz / black	41430	36
	1	4	0,75	schwarz / black	41437	36
GS = Gerade schneidend <i>GS = straight, cutting</i>						
GS 60 	2-0	3	0,75	schwarz / black	4170	36
KS = 1/2-gebogen außen schneidend <i>KS = 1/2 curved, reverse cutting</i>						
KS 20 	3-0	2	0,45	schwarz / black	4181*	36
HSPM, HSPM F = 1/2-Kreis SPATULA, PREMIUM-Schliff <i>HSPM, HSPM F = 1/2 circle, spatulated, PREMIUM cut</i>						
2 x HSPM 6 F 	8-0	0.4	0,30	schwarz / black	4195N ¹⁾	24
2 x HSPM 8 	6-0	0.7	0,45	weiß / white	4191	24
DSPM = 3/8-Kreis SPATULA, PREMIUM-Schliff <i>DSPM = 3/8 circle, spatulated, PREMIUM cut</i>						
DSPM 5 	8-0	0.4	0,30	schwarz / black	4202N ¹⁾	24
2 x DSPM 5 	8-0	0.4	0,30	schwarz / black	4206N ¹⁾	24
2 x DSPM 7 	8-0	0.4	0,45	schwarz / black	42015N ¹⁾	24
	7-0	0.5	0,45	schwarz / black	42021N ¹⁾	24
2 x DSPM 8 	6-0	0.7	0,45	schwarz / black	4208*	24

*eventuell mit verlängerter Lieferzeit verbunden / *possibly associated with an extended delivery time*

SEIDE / SILK

Sterile Nadel-Faden-Kombination / *needle suture combination, sterile*

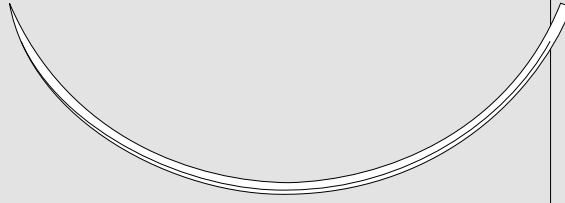
Nadel / needle	Stärke / gauge USP	gauge metric	Länge / length (m)	Farbe / colour	Best.-Nr. / code no.	Packungsinhalt / box content (Stück / pieces)
VSPM F = 1/4-Kreis SPATULA, PREMIUM-Schliff <i>VSPM F = 1/4 circle, spatulated, PREMIUM cut</i>						
2 x VSPM 8 F   PREMIUM-Schliff / <i>PREMIUM cut</i>	6-0	0.7	0,45	schwarz / <i>black</i>	4217*	24
	5-0	1	0,45	schwarz / <i>black</i>	4218	24
DSI = 3/8-Kreis innen schneidend <i>DSI = 3/8 circle, inner cutting</i>						
DSI 90 	2-0	3	1,00	schwarz / <i>black</i>	4343*	36
	0	3.5	1,00	schwarz / <i>black</i>	4344*	36
	1	4	1,00	schwarz / <i>black</i>	4345*	36

*eventuell mit verlängerter Lieferzeit verbunden / *possibly associated with an extended delivery time*

SEIDE / SILK

Einzelfadenpackungen, steril in vorgeschnittenen Längen
Sterile pre-cut suture, non-needed

Stärke / gauge USP	metric	Länge / length (m)	Farbe / colour	Best.-Nr. / code no.	Packungsinhalt / box content (Stück / pieces)
4-0	1.5	5 x 0,35	schwarz / black	G353*	24
3-0	2	5 x 0,35	schwarz / black	G453*	24
2-0	3	5 x 0,35	schwarz / black	G553*	24
4-0	1.5	3 x 0,50	schwarz / black	G335	24
3-0	2	3 x 0,50	schwarz / black	G435	24
2-0	3	3 x 0,50	schwarz / black	G535*	24
0	3.5	3 x 0,50	schwarz / black	G635*	24
1	4	3 x 0,50	schwarz / black	G735*	24
2	5	3 x 0,50	schwarz / black	G835*	24
0	3.5	3 x 0,50	weiß / white	WG635*	24
1	4	3 x 0,50	weiß / white	WG735*	24
4-0	1.5	5 x 0,50	schwarz / black	G355	24
3-0	2	5 x 0,50	schwarz / black	G455*	24
2-0	3	5 x 0,50	schwarz / black	G555	24
0	3.5	5 x 0,50	schwarz / black	G655*	24
1	4	5 x 0,50	schwarz / black	G755*	24
2	5	5 x 0,50	schwarz / black	G855*	24
3	6	5 x 0,50	schwarz / black	G955*	24
2-0	3	5 x 0,50	weiß / white	WG555*	24
0	3.5	5 x 0,50	weiß / white	WG655*	24
3-0	2	6 x 0,50	schwarz / black	SG455	24
2-0	3	6 x 0,50	schwarz / black	SG555*	24
0	3.5	6 x 0,50	schwarz / black	SG655	24
1	4	6 x 0,50	schwarz / black	SG755*	24
2	5	6 x 0,50	schwarz / black	SG855	24
2	5	6 x 0,50	weiß / white	WSG855*	24
5-0	1	10 x 0,50	schwarz / black	G2105*	24
4-0	1.5	10 x 0,50	schwarz / black	G3105*	24
3-0	2	10 x 0,50	schwarz / black	G4105*	24
2-0	3	10 x 0,50	schwarz / black	G5105*	24
0	3.5	10 x 0,50	schwarz / black	G6105*	24
1	4	10 x 0,50	schwarz / black	G7105*	24

*eventuell mit verlängerter Lieferzeit verbunden / possibly associated with an extended delivery time

SEIDE / SILK

Einzelfadenpackungen, steril in vorgeschnittenen Längen
Sterile pre-cut suture, non-needed

Stärke / gauge USP metric		Länge / length (m)	Farbe / colour	Best.-Nr. / code no.	Packungsinhalt / box content (Stück / pieces)
2-0	3	2 x 0,75	schwarz / black	G520	24
0	3.5	2 x 0,75	schwarz / black	G620	24
1	4	2 x 0,75	schwarz / black	G720	24
2	5	2 x 0,75	schwarz / black	G820	24
3	6	2 x 0,75	schwarz / black	G920	24
5	7	2 x 0,75	schwarz / black	G1020*	24
1	4	2 x 0,75	weiß / white	WG720*	24
2	5	2 x 0,75	weiß / white	WG820*	24
3	6	2 x 0,75	weiß / white	WG920*	24
3-0	2	5 x 0,75	schwarz / black	G450*	24
2-0	3	5 x 0,75	schwarz / black	G550*	24
0	3.5	5 x 0,75	schwarz / black	G650	24
1	4	5 x 0,75	schwarz / black	G750*	24
2	5	5 x 0,75	schwarz / black	G850	24
3-0	2	1 x 1,40	schwarz / black	SG411*	24
2-0	3	1 x 1,40	schwarz / black	SG511*	24
5	7	1 x 1,40	schwarz / black	S1011*	24

*eventuell mit verlängerter Lieferzeit verbunden / possibly associated with an extended delivery time

¹⁾ Produkt hergestellt durch / product manufactured by:



Healthium Medtech Private Limited (Formerly Sutures India Pvt. Ltd.)
 No. 472/D, 13th Cross, 4th Phase - Peenya Industrial Area, Bangalore 560 058, India
 Email: sales@suturesindia.com · Mfg. Lic. No.: KTK/28/283/96

STAHLDRAHT / STAINLESS STEEL

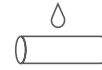

- nicht-resorbierbarer Stahldraht
- monofil
- hohe Zugfestigkeit
- sehr gewebefreundlich
- keine Dehnung

- *non- absorbable steel wire*
- *monofilament*
- *high tensile strength*
- *completely non-irritating*
- *non-stretch*

STAHLDRAHT / *STAINLESS STEEL*

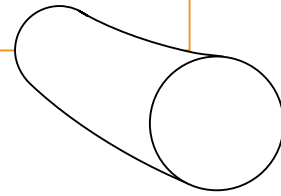

Eigenschaften:

- hohe, gleichbleibende Reißkraft
- keine Dehnung
- sehr geringe Gewebereaktion
- keine Dochtwirkung

Ein Mineralprodukt, hergestellt aus nichtrostender, korrosionsbeständiger Stahllegierung.

Aus flüssigem Stahl werden durch Formwerkzeuge Stahlfasern in den benötigten Stärken gezogen.

- ➔ Chemische Bezeichnung: nichtrostender Stahldraht
- ➔ Fadenstärke: USP 5-0 -7 (1-9 metric)
- ➔ Konfektionsangebote:
 - Nadel-Faden-Kombinationen
 - in vorgeschrittenen Längen
- ➔ Sterilisation: Ethylenoxid

Properties:

- *high, unchanging tear resistance*
- *no stretching*
- *minimal tissue reaction*
- *no wicking effect*



A mineral product manufactured from a stainless, non-corroding steel alloy.

Steel fibres are drawn from liquid steel through a suitable die to the required diameters.

- ➔ *Chemical name: stainless steel*
- ➔ *Thread diameter: USP 5-0 -7 (1-9 metric)*
- ➔ *Types of packaging:*
 - *needle-thread-combinations*
 - *precut lengths*
- ➔ *Sterilization method: ethylene oxide*

STAHLDRAHT / STAINLESS STEEL

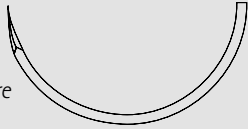
Sterile Nadel-Faden-Kombination / *needle suture combination, sterile*

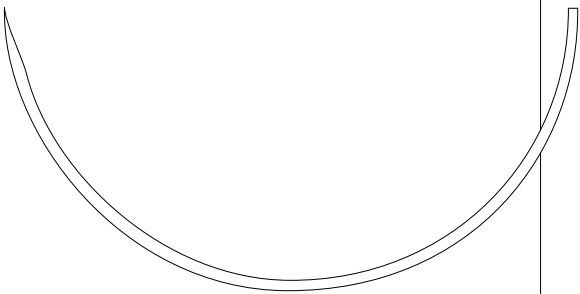
Nadel / needle	Stärke / gauge		Länge / length (m)	Farbe / colour	Best.-Nr. / code no.	Packungsinhalt / box content (Stück / pieces)
	USP	metric				
HRTX = 1/2-Kreis schneidende Rundkörper						
<i>HRTX = 1/2 circle, taper cutting</i>						
HRTX 50  Sternum-Naht / <i>Sternum-Suture</i>	5	7	1 x 0,45	monofil <i>monofilament</i>	L99061 (M-L)	12
	6	8	1 x 0,45	monofil <i>monofilament</i>	L99071* (M-L)	12
	7	9	1 x 0,45	monofil <i>monofilament</i>	L99069 (M-L)	12
	5	7	4 x 0,45	monofil <i>monofilament</i>	L99063 (M-L)	12
	6	8	4 x 0,45	monofil <i>monofilament</i>	L99064 (M-L)	12
	7	9	4 x 0,45	monofil <i>monofilament</i>	L99065 (M-L)	12
	5	7	6 x 0,45	monofil <i>monofilament</i>	L99066* (M-L)	12
	6	8	6 x 0,45	monofil <i>monofilament</i>	L99067 (M-L)	12
	7	9	6 x 0,45	monofil <i>monofilament</i>	L99070 (M-L)	12
	6	8	8 x 0,45	monofil <i>monofilament</i>	L99068* (M-L)	12
HS = Kreis außen schneidend						
<i>HS = 1/2 circle, reverse-cutting</i>						
HS 35 	2-0	3	0,60	monofil <i>monofilament</i>	99112	36
HS 120  Patella-Naht / <i>Patella-Suture Set</i>	3	6	0,60	monofil <i>monofilament</i>	99115	6

*eventuell mit verlängerter Lieferzeit verbunden / *possibly associated with an extended delivery time*

(M-L) = Multi-L-Pack

STAHLDRAHT / STAINLESS STEEL

Sterile Nadel-Faden-Kombination / *needle suture combination, sterile*

Nadel / needle	Stärke / gauge USP metric	Länge / length (m)	Farbe / colour	Best.-Nr. / code no.	Packungsinhalt / box content (Stück / pieces)
DS, DSM = 3/8-Kreis außen schneidend, mit PREMIUM-Schliff <i>DS; DSM = 3/8 circle, reverse cutting, PREMIUM cut</i>					
DSM 13 ▽ PREMIUM-Schliff / <i>PREMIUM cut</i>	5-0	1	0,45	monofil <i>monofilament</i>	99157* 36
	4-0	1.5	0,45	monofil <i>monofilament</i>	99158* 36
DS 18 ▼	5-0	1	0,45	monofil <i>monofilament</i>	99144* 36
	4-0	1.5	0,45	monofil <i>monofilament</i>	99145* 36
DS 26 ▼	1	4	0,45	monofil <i>monofilament</i>	L991418* (M-L) 12
DS 30 ▼ Sternum-Naht / <i>Sternum-suture</i>	2	5	1 x 0,45	monofil <i>monofilament</i>	L991417* (M-L) 12
	3	6	1 x 0,75	monofil <i>monofilament</i>	L991416* (M-L) 12

*eventuell mit verlängerter Lieferzeit verbunden / *possibly associated with an extended delivery time*

(M-L) = Multi-L-Pack

STAHLDRAHT / STAINLESS STEEL

Einzel-fadenpackungen, steril in vorgeschrittenen Längen
Sterile pre-cut suture, non-needed

Stärke / gauge USP metric	Länge / length (m)	Farbe / colour	Best.-Nr. / code no.	Packungsinhalt / box content (Stück / pieces)
2-0 3.5	x 0,15	monofil <i>monofilament</i>	V551*	24
0 3.5	5 x 0,15	monofil <i>monofilament</i>	V651*	24
0 3.5	3 x 0,50	monofil <i>monofilament</i>	V635*	24
1 4	3 x 0,50	monofil <i>monofilament</i>	V735*	24

*eventuell mit verlängerter Lieferzeit verbunden / *possibly associated with an extended delivery time*

Dental-Kombinationen

Dental Special Products

GLYCOLON® ORAL
RESOTEX® ORAL
SUPRAMID ORAL
DENTOFIL™

GLYCOLON® ORAL



- kurzfristig resorbierbares Monofilament
- hohe Reißkraft
- glatter Gewebedurchzug
- minimale Gewebereaktion
- guter Knotensitz

- *short term absorbable monofilament*
- *high tensile strength*
- *smooth tissue passage*
- *minimized tissue trauma*
- *perfect knot security*

GLYCOLON® ORAL

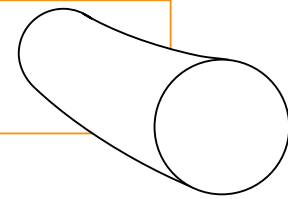

Eigenschaften:

- hohe Reißkraft
- guter Knotensitz
- atraumatischer Gewebedurchzug

Zur Herstellung von GLYCOLON® ORAL werden die beiden Materialbestandteile Polyglykolsäure und ϵ -Caprolacton in einem bestimmten Verhältnis copolymerisiert. Der Abbau des polymeren Fadenmaterials

im Gewebe erfolgt durch Wasseraufnahme in Umkehrung der Synthese. Nach Implantation nimmt die Reißkraft von GLYCOLON® ORAL nach 7 Tagen auf 30% ab. Gewebereaktionen werden zum einen durch die dabei entstehenden unbedenklichen Zwischenprodukte, zum anderen durch die monofile und glatte Oberflächenstruktur des Fadens minimiert. GLYCOLON® ORAL besitzt durch die glatten und monofilen Oberflächenstrukturen des Polymers ausgezeichnete Eigenschaften des Handlings und der Gleitfähigkeit. Gewebetraumatisierungen durch den Fadendurchzug sind bei

GLYCOLON® ORAL nicht relevant, die monofile Struktur verhindert Dochtwirkungen des Fadens ohne zusätzliche Oberflächenbehandlung. GLYCOLON® ORAL ist violett (mit dem physiologisch unbedenklichen Farbstoff D+C Nr. 2) eingefärbt erhältlich.

- Farbe: violett
- Chemische Bezeichnung: [Poly(Glykolsäure-co- ϵ -Caprolacton)]
- Fadenstärke: USP 5-0 (1 metric)
- Konfektionsangebote:
 - Nadel-Faden-Kombinationen
- Sterilisation: Ethylenoxid

Properties:

- high tear resistance
- excellent knot security
- atraumatic tissue passage

The two material components polyglycolic acid and ϵ -caprolactone are copolymerized in a certain ratio to make GLYCOLON® ORAL. Metabolization of the polymer suture within the tissue occurs by the uptake of water, thus reversing the synthesis.

After implantation of GLYCOLON® ORAL 30% of the original tensile strength left after 7 days.

Tissue reaction is minimal because of the completely safe intermediary products and the monofilament structure of thread.



GLYCOLON® ORAL with its smooth surface provides excellent handling properties and very good passage through tissue. Tissue trauma is minimal and there is no undesirable wick effect due to the monofilament structure of GLYCOLON® ORAL.

GLYCOLON® ORAL is supplied violet (dyed with the physiologically safe dye D+C No. 2).

- Colour: violet
- Chemical name: [poly (glycolic acid-co- ϵ -caprolactone)]
- Thread diameter: USP 5-0 (1 metric)
- Types of packaging:
 - needle-thread-combinations
- Sterilization method: ethylene oxide

GLYCOLON® ORAL

Sterile Nadel-Faden-Kombination / *needle suture combination, sterile*

Nadel / needle	Stärke / gauge		Länge / length (m)	Farbe / colour	Best.-Nr. / code no.	Packungsinhalt / box content (Stück / pieces)
	USP	metric				
DSM = 3/8-Kreis außen schneidend, mit PREMIUM-Schliff <i>DSM = 3/8 circle, reverse cutting, Premium cut</i>						
DSM 13 ▽  PREMIUM-Schliff / <i>PREMIUM cut</i>	5-0	1	0,45	violett / violet	DB15002S	12
DSM 16 ▽  PREMIUM-Schliff / <i>PREMIUM cut</i>	5-0	1	0,45	violett / violet	DB15001S	12
DSM 18 ▽  PREMIUM-Schliff / <i>PREMIUM cut</i>	5-0	1	0,45	violett / violet	DB15003S	12

*eventuell mit verlängerter Lieferzeit verbunden / *possibly associated with an extended delivery time*

RESOTEX® ORAL



- nicht-resorbierbares Material
 - überdurchschnittlich geschmeidig und weich
 - sehr gute Knüpfeigenschaften
 - hervorragender Gewebedurchzug
 - keine Kapillarität
 - geringe Gewebereaktion
- *non-absorbable suture*
 - *softer and more supple than average*
 - *perfect handling and knotting*
 - *easy passage through tissue*
 - *no capillarity*
 - *non-irritating*

RESOTEX® ORAL

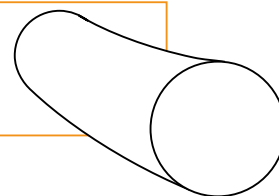

Eigenschaften:

- überdurchschnittlich weich und geschmeidig
- sehr gute Handhabungs- und Knüpfeigenschaften
- keine Kapillarität
- hervorragendes Gewebedurchzugsverhalten

RESOTEX® ORAL ist ein monofiles, nichtresorbierbares Nahtmaterial für die Oralchirurgie aus einem Copolymerisat aus Polyamid 6 und Polyamid 6.6. Durch seine monofile Struktur werden ohne zusätzliche Beschichtung eine Dochtwirkung und Gewebetraumatisierungen beim Fadendurchzug vermieden.

Das Material ist mit einem physiologisch unbedenklichen Farbstoff eingefärbt.

- Farbe: schwarz
- Chemische Bezeichnung: Polyamid 6-6.6
- Fadenstärke: USP 7-0 – 4-0 (0.5-1.5 metric)
- Konfektionsangebote:
 - Nadel-Faden-Kombinationen
- Sterilisation: Ethylenoxid

Properties:

- above-average softness and suppleness
- superior handling and knotting properties
- no capillarity
- excellent tissue passage

RESOTEX® ORAL is a monofilament, non-absorbable surgical suture material for oral surgery made from a copolymer of polyamide 6 and polyamide 6/6.







The monofilament structure without an additional coating prevents the wick effect and tissue trauma during passage through tissue.

The material is colored with a physiologically safe dye.

- Colour: black
- Chemical name: polyamide 6-6.6
- Thread diameter: USP 7-0 – 4-0 (0.5 - 1.5 metric)
- Types of packaging:
 - needle-thread-combinations
- Sterilization method: ethylene oxide

RESOTEX® ORAL

Sterile Nadel-Faden-Kombination / *needle suture combination, sterile*

Nadel / needle	Stärke / gauge		Länge / length (m)	Farbe / colour	Best.-Nr. / code no.	Packungsinhalt / box content (Stück / pieces)
	USP	metric				
ART = Asymptotische schneidende Rundkörper <i>ART = asymptotic, taper cutting</i>						
ART 13 ☉ 	6-0	0.7	0,45	schwarz / black	DB23001S	12
HRT = 1/2-Kreis schneidende Rundkörper <i>HRT = 1/2 circle, taper cutting</i>						
HRT 18 ☉ 	4-0	1.5	0,45	schwarz / black	DB22001S	12
DSM = 3/8-Kreis außen schneidend, mit PREMIUM-Schliff <i>DSM = 3/8 circle, reverse cutting, PREMIUM cut</i>						
DSM 11 ▽ 	6-0	0.7	0,45	schwarz / black	DB25007S	12
DSM 13 ▽ 	7-0	0.5	0,45	schwarz / black	DB25004S	12
	6-0	0.7	0,45	schwarz / black	DB25001S	12
	5-0	1	0,45	schwarz / black	DB25005S	12
DSM 16 ▽ 	5-0	1	0,45	schwarz / black	DB25003S	12
	4-0	1.5	0,45	schwarz / black	DB25002S	12
DSM 18 ▽ 	5-0	1	0,45	schwarz / black	DB25006S	12
GR = Gerade Rundkörper <i>GR = straight, taper point</i>						
GR 22 ● 	4-0	1.5	0,45	schwarz / black	DB28001S	12

*eventuell mit verlängerter Lieferzeit verbunden / *possibly associated with an extended delivery time*

SUPRAMID ORAL

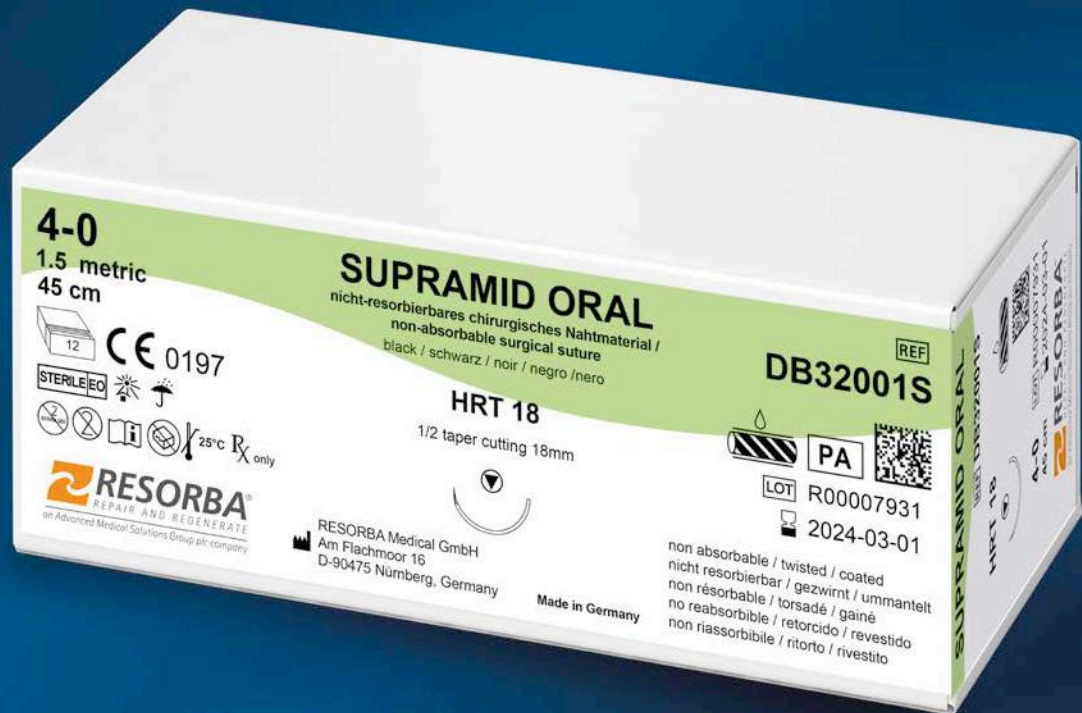

- nicht-resorbierbarer Polyamid-Faden
- sehr geschmeidig
- zugfest
- geringe Gewebereaktion
- gute Knoteneigenschaften

- *non-absorbable polyamide-suture*
- *very soft*
- *high tensile strength*
- *less tissue reaction*
- *good knotting properties*

SUPRAMID ORAL

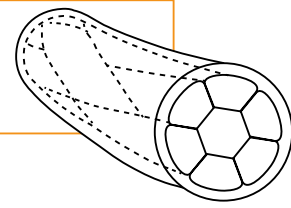

Eigenschaften:

- überdurchschnittlich weich und geschmeidig
- sehr gute Handhabungs- und Knüpfeigenschaften
- keine Kapillarität
- hervorragendes Gewebedurchzugsverhalten

SUPRAMID ORAL ist als monofiles, nichtresorbierbares Nahtmaterial aus einem Copolymerisat aus Polyamid 6 und Polyamid 6.6 erhältlich.

In stärkeren Durchmessern wird es als pseudomonofiles nicht-resorbierbares, chirurgisches Nahtmaterial aus Polyamid 6.6, einem Polymer von Hexamethylen-diamin und Adipin-säure, mit einer Beschichtung aus Polyamid 6, einem ϵ -Caprolactam-Polymer, angeboten.

Das Material ist mit einem physiologisch unbedenklichen Farbstoff eingefärbt.

- Farbe: schwarz
- Chemische Bezeichnung: Polyamid 6-6.6
- Fadenstärke: USP 4-0 (1.5 metric)
- Konfektionsangebote:
 - Nadel-Faden-Kombinationen
- Sterilisation: Ethylenoxid

Properties:

- above-average softness and suppleness
- superior handling and knotting properties
- no capillarity
- excellent tissue passage



SUPRAMID ORAL is a monofilament, non-absorbable surgical suture material for oral surgery made from a copolymer of polyamide 6 and polyamide 6/6. In larger diameters, it is supplied as pseudo-monofilament, non absorbable, surgical suture material made from polyamide 6/6, a polymer of hexamethylenediamine and adipic acid with a coating of polyamide 6, a ϵ -caprolactam-polymer.

The material is colored with a physiologically safe dye.

- Colour: black
- Chemical name: polyamide 6.6 and polyamide 6
- Thread diameter: USP 4-0 (1.5 metric)
- Types of packaging:
 - needle-thread-combinations
- Sterilization method: ethylene oxide

SUPRAMID ORAL

Sterile Nadel-Faden-Kombination / *needle suture combination, sterile*

Nadel / needle	Stärke / gauge		Länge / length (m)	Farbe / colour	Best.-Nr. / code no.	Packungsinhalt / box content (Stück / pieces)
	USP	metric				
HRT = 1/2-Kreis schneidende Rundkörper (Diamond-Spitze)						
<i>HRT = 1/2 circle, taper cutting</i>						
HRT 18 ⊙	4-0	1.5	0,45	schwarz / black	DB32001S	12
						
HS = 1/2-Kreis außen schneidend						
<i>HS = 1/2 circle, reverse cutting</i>						
HS 18 ▼	4-0	1.5	0,45	schwarz / black	DB31001S	12
						

*eventuell mit verlängerter Lieferzeit verbunden / *possibly associated with an extended delivery time*

DENTOFIL™



- PTFE Nahtmaterial
- nicht resorbierbar
- sehr geschmeidig
- sehr reißfest
- gut knüpfbar
- biologisch neutral

- *PTFE Suture Material*
- *non-absorbable*
- *extremely smooth*
- *very strong*
- *knots well*
- *biologically inert*

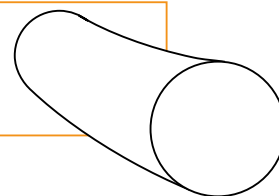

Eigenschaften:

- sehr geringe Reibung des monofilen Fadens minimiert mögliche Gewebeschäden
- atraumatische, öhrlose Nadeln gewährleisten geringsten Widerstand beim Einstich und Gleiten durch das Gewebe

DENTOFIL™ ist ein nicht resorbierbares, sehr geschmeidiges Nahtmaterial aus Polytetrafluorethylen (PTFE), das sehr reißfest, gut knüpfbar und biologisch neutral ist.

Besonders hervorzuheben ist die Geschmeidigkeit von DENTOFIL™, die dem Patientenkomfort sehr

zuträglich ist. Das Material hat einen sehr geringen Reibungskoeffizienten, d. h. im Vergleich zu anderen Materialien gleitet es leicht durch das Gewebe und minimiert dadurch die Wahrscheinlichkeit von Gewebeschäden. Diese Eigenschaft und die monofile Beschaffenheit verhindern die Möglichkeit des Eindringens von Bakterien in die Operationswunde.

Die atraumatischen, öhrlosen Nadeln sind aus einem nichtrostenden Spezialstahl mit optimaler Flexibilität und Festigkeit hergestellt. Eine spezielle Oberflächenbehandlung und ein präziser Schliff der Spitze bzw. Schneide gewährleisten geringsten Widerstand beim Einstich und beim Gleiten der Nadel durch das Gewebe. Die Prüfung der Nadelhaltekraft

erfolgt nach den Vorschriften der harmonisierten Normen für chirurgisches Nahtmaterial abgeleitet von der Europäischen Pharmakopoe.

DENTOFIL™ ist ein ideales Nahtmaterial für den Wundverschluss in der MKG-Chirurgie, z.B. nach augmentativen Verfahren und anderen implantologischen Eingriffen, bei denen die Verwendung eines weichen monofilen Fadens von Vorteil ist.

- ➔ Farbe: weiß
- ➔ Chemische Bezeichnung: Polytetrafluorethylen (PTFE)
- ➔ Fadenstärke: USP 5-0 - 3-0 (1 - 2 metric)
- ➔ Konfektionsangebote:
 - Nadel-Faden-Kombinationen
- ➔ Sterilisation: Ethylenoxid

Properties:

- very low friction of the thread minimizes the possibility of tissue damage
- atraumatic eyeless needles ensure minimal resistance to penetration and easy passage through the tissue

DENTOFIL™ is a non-absorbable, extremely smooth suture material made from polytetrafluoroethylene (PTFE) that is very strong, knots well, and is biologically inert.

Of particular note is the softness of DENTOFIL™, which makes it well

suited for patient comfort.

The material has a very low friction coefficient, meaning it slides easily through tissue compared to other materials, thereby limiting the possibility of tissue damage.

This feature, along with the monofilament construction, prevents the possibility of bacterial wicking into the surgical site.

The atraumatic eyeless needles are manufactured from special stainless steel of optimal flexibility and strength. Special surface treatment and precision grinding of needle points and cutting edges ensure minimal resistance to penetration and easy passage of the needle through the tissue. Testing of the needle holding force is performed







in accordance with the harmonised norms for surgical suture material derived from the European Pharmacopoeia.

DENTOFIL™ is an ideal suture material for wound closure in oral and maxillofacial surgery, including following bone grafts and other implant procedures where the use of a strong, smooth monofilament suture is highly beneficial.

- ➔ Colour: white
- ➔ Chemical name: polytetrafluoroethylene (PTFE)
- ➔ Thread diameter: USP 5-0 - 3-0 (1 - 2 metric)
- ➔ Types of packaging:
 - needle-thread-combinations
- ➔ Sterilization method: ethylene oxide

DENTOFIL™

Steriles PTFE Nahtmaterial / *PTFE Suture Material, sterile*

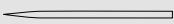
Nadel / needle	Stärke / gauge		Länge / length (m)	Farbe / colour	Best.-Nr. / code no.	Packungsinhalt / box content (Stück / pieces)
	USP	metric				
HR = 1/2-Kreis Rundkörper <i>HR = 1/2 circle, taper point</i>						
HR 13 ● 	4-0	1.5	0,45	weiß / white	DB46001	12
HRT = 1/2-Kreis schneidende Rundkörper (Diamond-Spitze) <i>HRT = 1/2 circle, taper cutting</i>						
HRT 17 ⊖ 	4-0	1.5	0,45	weiß / white	DB42004	12
	4-0	1.5	0,75	weiß / white	DB42003	12
	3-0	2	0,75	weiß / white	DB42002	12
HRT 22 ⊖ 	3-0	2	0,75	weiß / white	DB42001	12
DSM = 3/8-Kreis außen schneidend, mit PREMIUM-Schliff <i>DSM = 3/8 circle, reverse cutting, PREMIUM cut</i>						
DSM 11 ▼ 	5-0	1	0,45	weiß / white	DB45006	12
DSM 13 ▼ 	5-0	1	0,45	weiß / white	DB45007	12
	4-0	1.5	0,45	weiß / white	DB45002	12
DSM 16 ▼ 	5-0	1	0,45	weiß / white	DB45008	12
	4-0	1.5	0,45	weiß / white	DB45001	12
	3-0	2	0,45	weiß / white	DB44001	12
DSM 19 ▼ 	4-0	1.5	0,45	weiß / white	DB45005	12
	3-0	2	0,45	weiß / white	DB44002	12
GR = Gerade Rundkörper <i>GR = straight, taper point</i>						
GR 22 ● 	4-0	1.5	0,45	weiß / white	DB48001	12



Spezialkombinationen

Special Products



Spezial-Kombinationen / *Special Products*

Beschreibung / <i>description</i>	Länge / <i>length</i> (m)	Best.-Nr. / <i>code no.</i>	Packungsinhalt / <i>box content</i> (Stück / <i>pieces</i>)
Halteband, auch Nabel-, Zügelband <i>Tapes, umbilical threads</i>			
Nabel-, Zügelband, Baumwolle, weiß, geflochten, flach, 5 mm breit <i>Umbilical thread, cotton, white, braided, 5 mm</i>	0,75	104	12
ResoLOOPS			
Anschlingsschlauch (Retraktion) aus Silikon Kautschuk, steril im Folienbeutel <i>Silicone rubber encircling (retraction) loop, sterile in foil pouch</i>			
Ø 1,5 mm x 1,0 mm weiß / <i>white</i>	2 x 0,45	R15W	24
Ø 1,5 mm x 1,0 mm rot / <i>red</i>	2 x 0,45	R15R	24
Ø 1,5 mm x 1,0 mm blau / <i>blue</i>	2 x 0,45	R15B	24
Ø 1,5 mm x 1,0 mm gelb / <i>yellow</i>	2 x 0,45	R15G	24
Ø 2,5 mm x 1,0 mm weiß / <i>white</i>	2 x 0,45	R25W	12
Ø 2,5 mm x 1,0 mm rot / <i>red</i>	2 x 0,45	R25R	12
Ø 2,5 mm x 1,0 mm blau / <i>blue</i>	2 x 0,45	R25B	12
Ø 2,5 mm x 1,0 mm gelb / <i>yellow</i>	2 x 0,45	R25G	12
Ø 2,5 mm x 1,0 mm rot / <i>red</i>	2 x 0,75	R257R	12
Ø 2,5 mm x 1,0 mm blau / <i>blue</i>	2 x 0,75	R257B	12
Ø 2,5 mm x 1,0 mm gelb / <i>yellow</i>	2 x 0,75	R257G	12
Ø 5,0 mm x 1,0 mm weiß / <i>white</i>	2 x 0,45	R50W*	12
Ø 5,0 mm x 1,0 mm rot / <i>red</i>	2 x 0,45	R50R	12
Ø 5,0 mm x 1,0 mm blau / <i>blue</i>	2 x 0,45	R50B	12
Ø 5,0 mm x 1,0 mm gelb / <i>yellow</i>	2 x 0,45	R50G*	12
Ø 5,0 mm x 1,0 mm weiß / <i>white</i>	1 x 0,75	R507W*	12
Ø 5,0 mm x 1,0 mm rot / <i>red</i>	1 x 0,75	R507R	12
Ø 5,0 mm x 1,0 mm blau / <i>blue</i>	1 x 0,75	R507B	12
Ø 5,0 mm x 1,0 mm gelb / <i>yellow</i>	1 x 0,75	R507G*	12
ResoLOOPS dürfen nicht implantiert oder resterilisiert werden. <i>ResoLOOPS must not be implanted or resterilized.</i>			









*eventuell mit verlängerter Lieferzeit verbunden / *possibly associated with an extended delivery time*

Spezial-Kombinationen / *Special Products*

Beschreibung / <i>description</i>	Nadel / <i>needle</i>	Stärke / <i>gauge</i> USP	<i>gauge</i> metric	Länge / <i>length</i> (m)	Best.-Nr. / <i>code no.</i>	Packungsinhalt / <i>box content</i> (Stück / <i>pieces</i>)
Patella-Naht <i>Patella Suture</i>						
Draht monofil / <i>Steel monofil</i>	HS 120	3	6	0,60	99115*	6
Trochanter-Naht <i>Trochanter Suture</i>						
Polyester weiß geflochten, unbehandelt 1,0 mm <i>Polyester white, braided, untreated 1,0 mm</i>	-	-	-	1,50	101	12

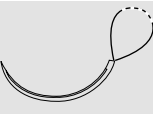
*eventuell mit verlängerter Lieferzeit verbunden / *possibly associated with an extended delivery time*

Spezial-Kombinationen / Special Products

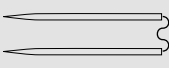
Nadel / needle		Stärke / gauge USP metric		Länge / length (m)	Farbe / colour	Best.-Nr. / code no.	Packungsinhalt / box content (Stück / pieces)	
Spezialsortiment Handchirurgie <i>Special combinations for Hand Surgery</i>								
DSM 11 ▽		PDO RESORBA™	6-0	0.7	0,45	violett / violet	PN2151 ¹⁾	24
		MOPYLEN®	6-0	0.7	0,45	blau / blue	7152	36
DSM 13 ▽		PDO RESORBA™	5-0	1	0,45	violett / violet	PN2154 ¹⁾	24
		PDO RESORBA™	4-0	1.5	0,45	violett / violet	PN2155 ¹⁾	24
		MOPYLEN®	6-0	0.7	0,45	blau / blue	7155	36
		MOPYLEN®	5-0	1	0,45	blau / blue	7156	36
		SUPOLENE	5-0	1	0,45	grün / green	9152	36
		SUPOLENE	4-0	1.5	0,45	grün / green	9153	36
DSM 16 ▽		MOPYLEN®	4-0	1.5	0,45	blau / blue	71511	36
DSM 18 ▽		PDO RESORBA™	4-0	1.5	0,45	violett / violet	PN21510 ¹⁾	24
		MOPYLEN®	4-0	1.5	0,45	blau / blue	71513	36
		MOPYLEN®	3-0	2	0,45	blau / blue	71514	36
DS 18 ▼		PDO RESORBA™	4-0	1.5	0,30	violett / violet	PN2149 ¹⁾	24
		MOPYLEN®	4-0	1.5	0,30	blau / blue	71447*	36
		MOPYLEN®	3-0	2	0,30	blau / blue	71448*	36
DR 18 ●		PDO RESORBA™	4-0	1.5	0,30	violett / violet	PN2079 ¹⁾	24
		PDO RESORBA™	3-0	2	0,30	violett / violet	PN2078 ¹⁾	24
		MOPYLEN®	4-0	1.5	0,30	blau / blue	70734*	36
		MOPYLEN®	3-0	2	0,30	blau / blue	70733*	36
		RESOPREN®	4-0	1.5	0,30	blau / blue	770725*	36
		RESOPREN®	3-0	2	0,30	blau / blue	770724*	36
DRTM 12 ▽		PDO RESORBA™	5-0	1	0,70	violett / violet	PN2256 ¹⁾	24
		MOPYLEN®	6-0	1	0,75	blau / blue	7258*	36
DRT 18 ▽		PDO RESORBA™	4-0	1.5	0,45	violett / violet	PN2081 ¹⁾	24
		MOPYLEN®	4-0	1.5	0,75	blau / blue	7089*	36
		SUPRAMID	4-0	1.5	0,50	weiß / white	6080	36
GR 20 ●		PDO RESORBA™	4-0	1.5	0,35	violett / violet	PN2091 ¹⁾	24

*eventuell mit verlängerter Lieferzeit verbunden / possibly associated with an extended delivery time

¹⁾ Produkt hergestellt durch / product manufactured by:

 Healthium Medtech Private Limited (Formerly Sutures India Pvt. Ltd.)
No. 472/D, 13th Cross, 4th Phase - Peenya Industrial Area, Bangalore 560 058, India
Email: sales@suturesindia.com · Mfg. Lic. No.: KTK/28/283/96

Chirurgische Federöhrnadeln

Spring-eyed needles



Gehärteter Edelstahl:

- hohe Biegefestigkeit
- garantiert rostfrei

Optimiertes Federöhrdesign:

- sicherer Fadenhalt
- vermindert das Risiko einer Verletzung der Fadenoberfläche
- schnelles und leichtes Einfädeln durch optimale Elastizität des Federöhrs

Präzisionsschliff:

- Reduzierung des Wundtraumas durch scharfen Kantenschliff
- hohe Penetrationsfähigkeit

Tempered stainless steel:

- *high bending resistance*
- *guaranteed rustproof*

Optimised spring eye design:









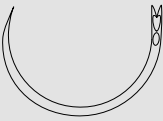

- *secure hold for the suture*
- *reduces the risk of damage to the suture's surface*
- *fast and easy suture insertion due to the optimal elasticity of the spring eye*

Precision honing:

- *sharply honed cutting edge reduces tissue trauma*
- *excellent penetration ability*

Chirurgische Federöhrnadeln – unsteril

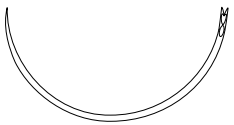



Spring-eyed needles – non sterile

Nadel / needle	Nadelbezeichnung needle type	Euro-Code Europ. code	Best.-Nr. code no.	Inhalt Blister blister content
H (318) = 5/8-Kreis Rundkörper, standard <i>H (318) = 5/8 circle, taper point, standard</i>				
FR 42 ● 	H 318 / 2 F	R 42 (130)	OEFR42	3
G (312) = 1/2-Kreis Rundkörper, standard <i>G (312) = 1/2 circle, taper point, standard</i>				
HR 20 ● 	G 312 /15	HR 20(70)	OEHR20	6
HR 23 ● 	G 312 /14	HR 23(80)	OEHR23	6
HR 26 ● 	G 312 /13	HR 26(80)	OEHR26	6
HR 30 ● 	G 312 /12	HR 30(80)	OEHR30	6
HR 34 ● 	G 312 /11	HR 34(90)	OEHR34	6
HR 38 ● 	G 312 /10	HR 38(90)	OEHR38	6
HR 42 ● 	G 312 /9	HR 42(100)	OEHR42	6
HR 46 ● 	G 312 /8	HR 46(100)	OEHR46	6
HR 50 ● 	G 312 /7	HR 50(110)	OEHR50	6

*eventuell mit verlängerter Lieferzeit verbunden / possibly associated with an extended delivery time

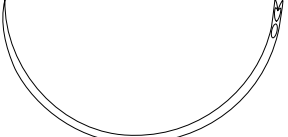
Chirurgische Federöhrnadeln – unsteril

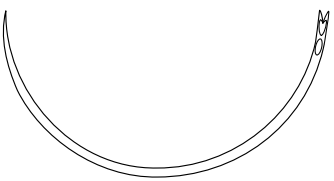

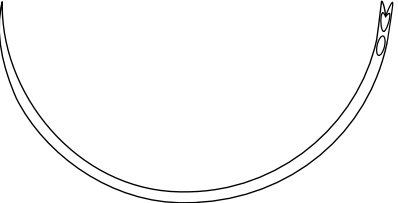
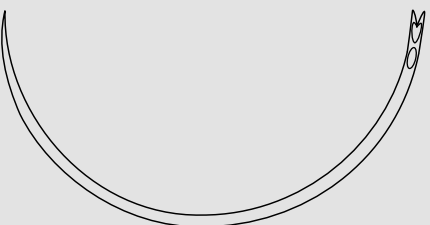



Spring-eyed needles – non sterile

Nadel / needle	Nadelbezeichnung needle type	Euro-Code Europ. code	Best.-Nr. code no.	Inhalt Blister blister content
HR 54 ● 	G 312 /6	HR 54(110)	OEHR54	3
HR 58 ● 	G 312 /5	HR 58(120)	OEHR58	3
HR 63 ● 	G 312 /4	HR 63(130)	OEHR63*	3
HR 68 ● 	G 312 /3	HR 68(130)	OEHR68*	3
HR 73 ● 	G 312 /2	HR 73(140)	OEHR73	3
HR 80 ● 	G 312 /1	HR 80(140)	OEHR80*	3
HR 86 ● 	G 312 /0	HR 86(160)	OEHR86*	3

*eventuell mit verlängerter Lieferzeit verbunden / possibly associated with an extended delivery time

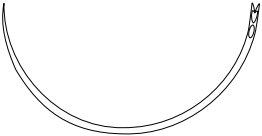
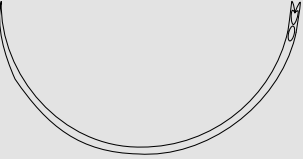
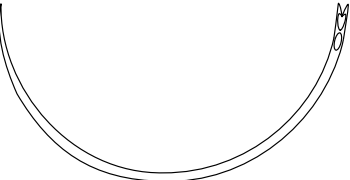
Chirurgische Federöhrnadeln – unsteril

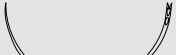





Spring-eyed needles – non sterile

Nadel / needle	Nadelbezeichnung needle type	Euro-Code Europ. code	Best.-Nr. code no.	Inhalt Blister blister content
E (320) = 1/2-Kreis Rundkörper, fein <i>E (320) = 1/2 circle, taper point, thin</i>				
HR 18 F ● 	E 320/6	HR 18(60)	OEHR18F	6
HR 20 F ● 	E 320/5	HR 20(60)	OEHR20F	6
HR 23 F ● 	E 320/4	HR 23(70)	OEHR23F	6
HR 54 F ● 	E 320/0	HR 54(100)	OEHR54F*	3
HR 63 F ● 	E 320/00	HR 63(110)	OEHR63F*	3
HR 72 F ● 	E 320/000	HR 72(110)	OEHR72F	3
Pb (332) = 1/2-Kreis Rundkörper, extra fein <i>Pb (332) = 1/2 circle, taper point, extra thin</i>				
HR 24 FF ● 	Pb 332/5	HR 24(60)	OEHR24FF	6
HR 30 FF ● 	Pb 332/4	HR 30(60)	OEHR30FF	6
HR 36 FF ● 	Pb 332/3	HR 36(60)	OEHR36FF	6
HR 42 FF ● 	Pb 332/2	HR 42(70)	OEHR42FF	6

*eventuell mit verlängerter Lieferzeit verbunden / possibly associated with an extended delivery time

Chirurgische Federöhrnadeln – unsteril

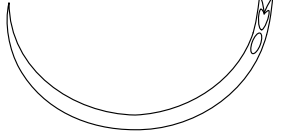

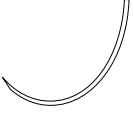







Spring-eyed needles – non sterile

Nadel / needle	Nadelbezeichnung needle type	Euro-Code Europ. code	Best.-Nr. code no.	Inhalt Blister blister content
GaR (314) = 1/2-Kreis Rundkörper, stark <i>GaR (314) = 1/2 circle, taper point, strong diameter</i>				
HR 23 S ● 	GaR 314 /8	HR 23(100)	OEHR23S*	6
HR 27 S ● 	GaR 314 /7	HR 27(100)	OEHR27S	6
HR 32 S ● 	GaR 314 /6	HR 32(110)	OEHR32S	6
HR 38 S ● 	GaR 314 /5	HR 38(130)	OEHR38S	6
HR 46 S ● 	GaR 314 /4	HR 46(140)	OEHR46S	6
HR 54 S ● 	GaR 314 /3	HR 54(140)	OEHR54S*	3
HR 60 S ● 	GaR 314 /2	HR 60(160)	OEHR60S	3
Asymptotische schneidende Rundkörper <i>asymptotic, taper cutting</i>				
ART 13 ▼ 	-	ART 13(60)	OEART13*	6
ART 25 ▼ 	-	ART 25(80)	OEART25*	6

*eventuell mit verlängerter Lieferzeit verbunden / possibly associated with an extended delivery time

Chirurgische Federöhrnadeln – unsteril

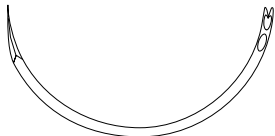



Spring-eyed needles – non sterile

Nadel / needle		Nadelbezeichnung needle type	Euro-Code Europ. code	Best.-Nr. code no.	Inhalt Blister blister content
G (412) = 1/2-Kreis schneidende Rundkörper (Diamond Spitze) G (412) = 1/2 circle, taper cutting					
HRT 20 ▼		G 412 /15	HRT 20(70)	OEHRT20	6
HRT 23 ▼		G 412 /14	HRT 23(80)	OEHRT23	6
HRT 26 ▼		G 412 /13	HRT 26(80)	OEHRT26	6
HRT 30 ▼		G 412 /12	HRT 30(80)	OEHRT30	6
HRT 34 ▼		G 412 /11	HRT 34(90)	OEHRT34	6
HRT 38 ▼		G 412 /10	HRT 38(90)	OEHRT38	6
HRT 42 ▼		G 412 /9	HRT 42(100)	OEHRT42	6
HRT 46 ▼		G 412 /8	HRT 46(100)	OEHRT46	6
HRT 50 ▼		G 412 /7	HRT 50(110)	OEHRT50	6
HRT 54 ▼		G 412 /6	HRT 54(110)	OEHRT54	3
HRT 58 ▼		G 412 /5	HRT 58(120)	OEHRT58	3

*eventuell mit verlängerter Lieferzeit verbunden / possibly associated with an extended delivery time

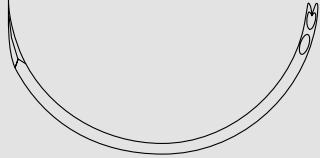
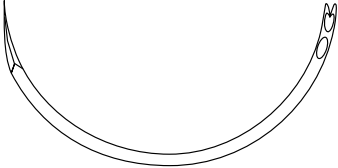
Chirurgische Federöhrnadeln – unsteril



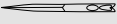







Spring-eyed needles – non sterile

Nadel / needle	Nadelbezeichnung needle type	Euro-Code Europ. code	Best.-Nr. code no.	Inhalt Blister blister content	
HRT 63 ▼		G 412 /4	HRT 63(130)	OEHRT63	3
HRT 68 ▼		G 412 /3	HRT 68(130)	OEHRT68	3
1/2-Kreis schneidende Rundkörper (Diamond Spitze), stark <i>1/2 circle, taper cutting, strong diameter</i>					
HRT 30 S ▼		-	HRT 30(110)	OEHRT30S*	6
HRT 34 S ▼		-	HRT 34(120)	OEHRT34S*	6
B (304) = 3/8-Kreis Rundkörper <i>B (304) = 3/8 circle, taper point</i>					
DR 20 F ●		B 304 /15	DR 20(60)	OEDR20F	6
Gerade schneidende Rundkörper (Diamond Spitze) <i>straight, taper cutting</i>					
GRT 15 ▼		-	GRT 15(80)	OEGRT15*	20

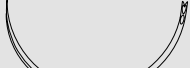
*eventuell mit verlängerter Lieferzeit verbunden | possibly associated with an extended delivery time

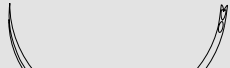
Chirurgische Federöhrnadeln – unsteril

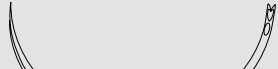





Spring-eyed needles – non sterile

Nadel / needle	Nadelbezeichnung needle type	Euro-Code Europ. code	Best.-Nr. code no.	Inhalt Blister blister content
GT (212) = 1/2-Kreis außen schneidend, standard GT (212) = 1/2 circle, reverse cutting, standard				
HS 23 ▼ 	GT 212 /14	HS 23(80)	OEHS23	6
HS 26 ▼ 	GT 212 /13	HS 26(80)	OEHS26	6
HS 30 ▼ 	GT 212 /12	HS 30(80)	OEHS30	6
HS 34 ▼ 	GT 212 /11	HS 34(90)	OEHS34	6
HS 38 ▼ 	GT 212 /10	HS 38(90)	OEHS38	6
HS 42 ▼ 	GT 212 /9	HS 42(100)	OEHS42	6
HS 46 ▼ 	GT 212 /8	HS 46(100)	OEHS46	6
HS 50 ▼ 	GT 212 /7	HS 50(110)	OEHS50	6
HS 54 ▼ 	GT 212 /6	HS 54(110)	OEHS54	3
HS 58 ▼ 	GT 212 /5	HS 58(120)	OEHS58	3

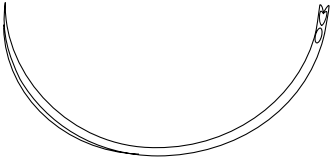
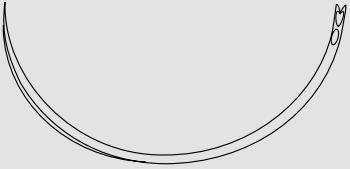
*eventuell mit verlängerter Lieferzeit verbunden / possibly associated with an extended delivery time

Chirurgische Federöhrnadeln – unsteril

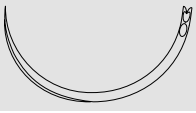









Spring-eyed needles – non sterile

Nadel / needle	Nadelbezeichnung needle type	Euro-Code Europ. code	Best.-Nr. code no.	Inhalt Blister blister content
HS 63 ▼ 	GT 212 /4	HS 63(130)	OEHS63	3
HS 68 ▼ 	GT 212 /3	HS 68(130)	OEHS68	3
HS 73 ▼ 	GT 212 /2	HS 73(140)	OEHS73	3
GaT (214) = 1/2-Kreis außen schneidend, stark <i>GaT (214) = 1/2 circle, reverse cutting, strong diameter</i>				
HS 18 S ▼ 	GaT 214 /9	HS 18(90)	OEHS18S	6
HS 23 S ▼ 	GaT 214 /8	HS 23(100)	OEHS23S	6
HS 27 S ▼ 	GaT 214 /7	HS 27(100)	OEHS27S	6
HS 32 S ▼ 	GaT 214 /6	HS 32(110)	OEHS32S	6
HS 38 S ▼ 	GaT 214 /5	HS 38(130)	OEHS38S	6
HS 46 S ▼ 	GaT 214 /4	HS 46(140)	OEHS46S	6
HS 54 S ▼ 	GaT 214 /3	HS 54(140)	OEHS54S	3

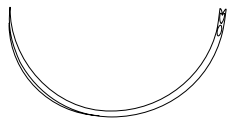
*eventuell mit verlängerter Lieferzeit verbunden | possibly associated with an extended delivery time

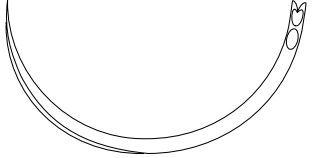
Chirurgische Federöhrnadeln – unsteril











Spring-eyed needles – non sterile

Nadel / needle	Nadelbezeichnung needle type	Euro-Code Europ. code	Best.-Nr. code no.	Inhalt Blister blister content
HS 63 S 	GaT 214 /2	HS 63(150)	OEHS63S	3
Ga (214) = 1/2-Kreis innen schneidend, stark <i>Ga (214) = 1/2 circle, inner cutting, strong diameter</i>				
HSI 18 S 	Ga 214 /9	HSI 18(90)	OEHSI18S	6
HSI 27 S 	Ga 214 /7	HSI 27(100)	OEHSI27S	6
HSI 32 S 	Ga 214 /6	HSI 32(110)	OEHSI32S	6
HSI 46 S 	Ga 214 /4	SI 46(140)	OEHSI46S	6
HSI 54 S 	Ga 214 /3	HSI 54(140)	OEHSI54S	6
HSI 63 S 	Ga 214 /2	HSI 63(150)	OEHSI 63S	6
BT (204) = 3/8-Kreis außen schneidend, standard <i>BT (204) = 3/8 circle, reverse cutting, standard</i>				
DS 18 	BT 204 /16	DS 18(70)	OEDS18	6
DS 20 	BT 204 /15	DS 20(70)	OEDS20	6
DS 23 	BT 204 /14	DS 23(80)	OEDS23	6

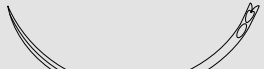
*eventuell mit verlängerter Lieferzeit verbunden | possibly associated with an extended delivery time

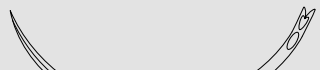
Chirurgische Federöhrnadeln – unsteril

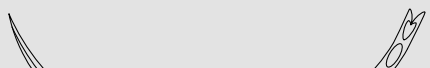







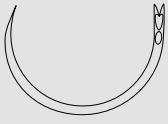

Spring-eyed needles – non sterile

Nadel / needle		Nadelbezeichnung needle type	Euro-Code Europ. code	Best.-Nr. code no.	Inhalt Blister blister content
DS 26 ▼		BT 204 /13	DS 26(80)	OEDS26	6
DS 30 ▼		BT 204 /12	DS 30(80)	OEDS30	6
DS 34 ▼		BT 204 /11	DS 34(90)	OEDS34	6
DS 38 ▼		BT 204 /10	DS 38(90)	OEDS38	6
DS 42 ▼		BT 204 /9	DS 42(100)	OEDS42	6
DS 46 ▼		BT 204 /8	DS 46(100)	OEDS46	3
DS 50 ▼		BT 204 /7	DS 50(110)	OEDS50	3
DS 54 ▼		BT 204 /6	DS 54(110)	OEDS54	3
DS 70 ▼		BT 204 /3	DS 70(130)	OEDS70*	3
Gerade schneidend, standard (Keith) <i>straight, cutting, standard (Keith)</i>					
GS 20 ▼		-	GS 20(80)	OEGS20*	20

*eventuell mit verlängerter Lieferzeit verbunden | possibly associated with an extended delivery time

Chirurgische Federöhrnadeln – steril

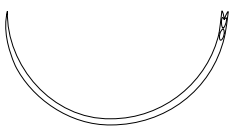
Spring-eyed needles – sterile

Nadel / needle	Nadelbezeichnung needle type	Euro-Code Europ. code	Best.-Nr. code no.	Inhalt Blister blister content
H (318) = 5/8-Kreis Rundkörper, standard <i>H (318) = 5/8 circle, taper point, standard</i>				
FR 42 ● 	H 318 / 2	FR 42 (130)	OESFR42	48
G (312) = 1/2-Kreis Rundkörper, standard <i>G (312) = 1/2 circle, taper point, standard</i>				
HR 20 ● 	G 312 /15	HR 20(70)	OESHR20*	48
HR 23 ● 	G 312 /14	HR 23(80)	OESHR23*	48
HR 26 ● 	G 312 /13	HR 26(80)	OESHR26*	48
HR 30 ● 	G 312 /12	HR 30(80)	OESHR30	48
HR 34 ● 	G 312 /11	HR 34(90)	OESHR34	48
HR 38 ● 	G 312 /10	HR 38(90)	OESHR38	48
HR 42 ● 	G 312 /9	HR 42(100)	OESHR42	48
HR 46 ● 	G 312 /8	HR 46(100)	OESHR46	48
HR 50 ● 	G 312 /7	HR 50(110)	OESHR50*	48

*eventuell mit verlängerter Lieferzeit verbunden / possibly associated with an extended delivery time

Chirurgische Federöhrnadeln – steril









Spring-eyed needles – sterile

Nadel / needle		Nadelbezeichnung needle type	Euro-Code Europ. code	Best.-Nr. code no.	Inhalt Blister blister content
HR 54 ●		G 312 /6	HR 54(110)	OESHR54	48
HR 58 ●		G 312 /5	HR 58(120)	OESHR58	48
HR 63 ●		G 312 /4	HR 63(130)	OESHR63*	48
HR 68 ●		G 312 /3	HR 68(130)	OESHR68*	48
HR 73 ●		G 312 /2	HR 73(140)	OESHR73*	48

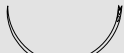
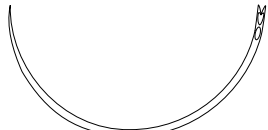
*eventuell mit verlängerter Lieferzeit verbunden / possibly associated with an extended delivery time

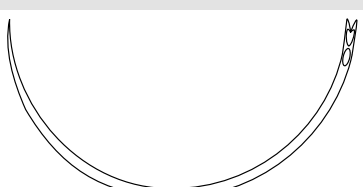
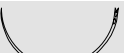
Chirurgische Federöhrnadeln – steril

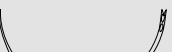







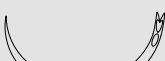

Spring-eyed needles – sterile

Nadel / needle	Nadelbezeichnung needle type	Euro-Code Europ. code	Best.-Nr. code no.	Inhalt Blister blister content
E (320) = 1/2-Kreis Rundkörper, fein <i>E (320) = 1/2 circle, taper point, thin</i>				
HR 18 F ● 	E 320 /6	HR 18(60)	OESHR18F*	48
HR 20 F ● 	E 320 /5	HR 20(60)	OESHR20F*	48
HR 23 F ● 	E 320 /4	HR 23(70)	OESHR23F*	48
HR 54 F ● 	E 320 /0 HR	54(100)	OESHR54F*	48
HR 63 F ● 	E 320 /00	HR 63(110)	OESHR63F*	48
HR 72 F ● 	E 320 /000	HR 72(110)	OESHR72F*	48
Pb (332) = 1/2-Kreis Rundkörper, extra fein <i>Pb (332) = 1/2 circle, taper point, extra thin</i>				
HR 24 FF ● 	Pb 332 /5	HR 24(60)	OESHR24FF*	48
HR 30 FF ● 	Pb 332 /4	HR 30(60)	OESHR30FF*	48
HR 36 FF ● 	Pb 332 /3	HR 36(60)	OESHR36FF*	48
HR 42 FF ● 	Pb 332 /2	HR 42(70)	OESHR42FF*	48

*eventuell mit verlängerter Lieferzeit verbunden | possibly associated with an extended delivery time

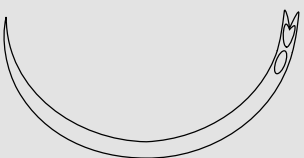
Chirurgische Federöhrnadeln – steril





Spring-eyed needles – sterile

Nadel / needle		Nadelbezeichnung needle type	Euro-Code Europ. code	Best.-Nr. code no.	Inhalt Blister blister content
GaR (314) = 1/2-Kreis Rundkörper, stark <i>GaR (314) = 1/2 circle, taper point, strong diameter</i>					
HR 23 S ●		GaR 314 /8	HR 23(100)	OESHR23S*	48
HR 27 S ●		GaR 314 /7	HR 27(100)	OESHR27S*	48
HR 32 S ●		GaR 314 /6	HR 32(110)	OESHR32S	48
HR 38 S ●		GaR 314 /5	HR 38(130)	OESHR38S	48
HR 46 S ●		GaR 314 /4	HR 46(140)	OESHR46S	48
HR 54 S ●		GaR 314 /3	HR 54(140)	OESHR54S*	48
HR 60 S ●		GaR 314 /2	HR 60(160)	OESHR60S*	48
G (412) = 1/2-Kreis schneidende Rundkörper (Diamond Spitze) <i>G (412) = 1/2 circle, taper cutting</i>					
HRT 20 ▼		G 412 /15	HRT 20(70)	OESHRT20*	48
HRT 23 ▼		G 412 /14	HRT 23(80)	OESHRT23*	48
HRT 26 ▼		G 412 /13	HRT 26(80)	OESHRT26*	48
HRT 30 ▼		G 412 /12	HRT 30(80)	OESHRT30*	48

*eventuell mit verlängerter Lieferzeit verbunden / possibly associated with an extended delivery time

Chirurgische Federöhrnadeln – steril

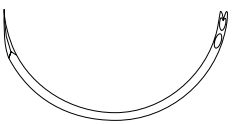

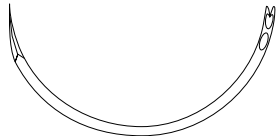
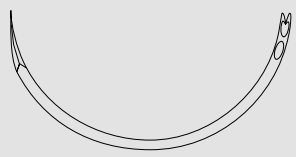
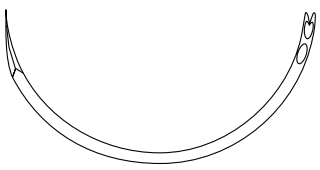
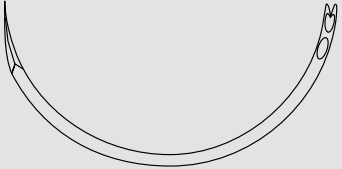





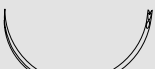

Spring-eyed needles – sterile

Nadel / needle		Nadelbezeichnung needle type	Euro-Code Europ. code	Best.-Nr. code no.	Inhalt Blister blister content
HRT 34 ●		G 412 /11	HRT 34(90)	OESHRT34*	48
HRT 38 ●		G 412 /10	HRT 38(90)	OESHRT38*	48
HRT 42 ●		G 412 /9	HRT 42(100)	OESHRT42*	48
HRT 46 ●		G 412 /8	HRT 46(100)	OESHRT46	48
HRT 50 ●		G 412 /7	HRT 50(110)	OESHRT50*	48
HRT 54 ●		G 412 /6	HRT 54(110)	OESHRT54*	48
HRT 58 ●		G 412 /5	HRT 58(120)	OESHRT58*	48
HRT 63 ●		G 412 /4	HRT 63(130)	OESHRT63*	48
HRT 68 ●		G 412 /3	HRT 68(130)	OESHRT68*	48

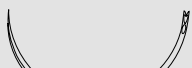
*eventuell mit verlängerter Lieferzeit verbunden / possibly associated with an extended delivery time

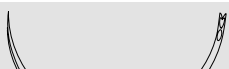
Chirurgische Federöhrnadeln – steril

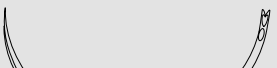

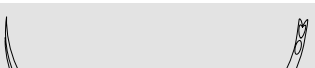



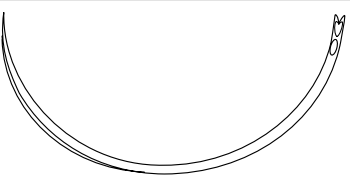

Spring-eyed needles – sterile

Nadel / needle	Nadelbezeichnung needle type	Euro-Code Europ. code	Best.-Nr. code no.	Inhalt Blister blister content	
GT (212) = 1/2-Kreis außen schneidend, standard GT (212) = 1/2 circle, reverse cutting, standard					
HS 23 ▼		GT 212 /14	HS 23(80)	OESHS23*	48
HS 26 ▼		GT 212 /13	HS 26(80)	OESHS26*	48
HS 30 ▼		GT 212 /12	HS 30(80)	OESHS30*	48
HS 34 ▼		GT 212 /11	HS 34(90)	OESHS34*	48
HS 38 ▼		GT 212 /10	HS 38(90)	OESHS38*	48
HS 42 ▼		GT 212 /9	HS 42(100)	OESHS42*	48
HS 46 ▼		GT 212 /8	HS 46(100)	OESHS46*	48
HS 50 ▼		GT 212 /7	HS 50(110)	OESHS50*	48
HS 54 ▼		GT 212 /6	HS 54(110)	OESHS54	48
HS 58 ▼		GT 212 /5	HS 58(120)	OESHS58*	48
HS 63 ▼		GT 212 /4	HS 63(130)	OESHS63*	48

*eventuell mit verlängerter Lieferzeit verbunden / possibly associated with an extended delivery time

Chirurgische Federöhrnadeln – steril

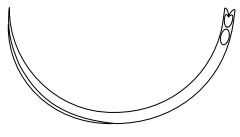









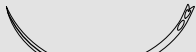

Spring-eyed needles – sterile

Nadel / needle	Nadelbezeichnung needle type	Euro-Code Europ. code	Best.-Nr. code no.	Inhalt Blister blister content
HS 68 	GT 212 /3	HS 68(130)	OESHS68*	48
HS 73 	GT 212 /2	HS 73(140)	OESHS73*	48
GaT (214) = 1/2-Kreis außen schneidend, stark <i>GaT (214) = 1/2 circle, reverse cutting, strong diameter</i>				
HS 18 S 	GaT 214 /9	HS 18(90)	OESHS18S*	48
HS 23 S 	GaT 214 /8	HS 23(100)	OESHS23S	48
HS 27 S 	GaT 214 /7	HS 27(100)	OESHS27S	48
HS 32 S 	GaT 214 /6	HS 32(110)	OESHS32S	48
HS 38 S 	GaT 214 /5	HS 38(130)	OESHS38S	48
HS 46 S 	GaT 214 /4	HS 46(140)	OESHS46S	48
HS 54 S 	GaT 214 /3	HS 54(140)	OESHS54S	48

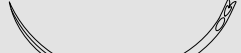
*eventuell mit verlängerter Lieferzeit verbunden / possibly associated with an extended delivery time

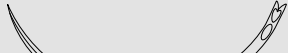
Chirurgische Federöhrnadeln – steril

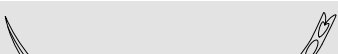
Spring-eyed needles – sterile

Nadel / needle		Nadelbezeichnung needle type	Euro-Code Europ. code	Best.-Nr. code no.	Inhalt Blister blister content
BT (204) = 3/8-Kreis außen schneidend, standard BT (204) = 3/8 circle, reverse cutting, standard					
DS 18 ▼		BT 204 /16	DS 18(70)	OESDS18*	48
DS 20 ▼		BT 204 /15	DS 20(70)	OESDS20*	48
DS 23 ▼		BT 204 /14	DS 23(80)	OESDS23*	48
DS 26 ▼		BT 204 /13	DS 26(80)	OESDS26*	48
DS 30 ▼		BT 204 /12	DS 30(80)	OESDS30*	48
DS 34 ▼		BT 204 /11	DS 34(90)	OESDS34*	48
DS 38 ▼		BT 204 /10	DS 38(90)	OESDS38	48
DS 42 ▼		BT 204 /9	DS 42(100)	OESDS42	48
DS 46 ▼		BT 204 /8	DS 46(100)	OESDS46*	48
DS 50 ▼		BT 204 /7	DS 50(110)	OESDS50*	48
DS 54 ▼		BT 204 /6	DS 54(110)	OESDS54*	48
DS 70 ▼		BT 204 /3	DS 70(130)	OESDS70*	48

*eventuell mit verlängerter Lieferzeit verbunden / possibly associated with an extended delivery time



P1301 2019-08

RESORBA Medical GmbH, Am Flachmoor 16, 90475 Nürnberg, Germany
Tel: +49 9128 / 91 15 0 Fax: +49 9128 / 91 15 91 Email: infomail@resorba.com
www.resorba.com

